

## GROVE® TMS900E

### product guide

#### features

- 90 ton (80 mton) capacity
- 37-142 ft (11.2 - 43.2 m) 5 section full power boom
- Patented TWIN-LOCK boom pinning system
- 33 - 56 ft (10 - 17m) bifold lattice swingaway extension
- Optional 33 - 56 ft (10 - 17 m) hydraulically offsettable bifold swingaway
- Optional lattice insert extensions for a 237 ft (72.2 m) maximum tip height
- Grove MEGAFORM boom
- Hydraulically tiltable cab up to 15°
- Up to 31,500 lbs hydraulically installed/removed counterweight
- Cummins 6 cylinder, turbo-charged after cooled diesel engine
- 65 mph (104 kph) travel speed



#### contents

Features	2
Specifications	3
Dimensions	5
Travel Proposal	6
Working Range	7
Main Boom Charts	9
31,5 Counterweight	10
27,2 Counterweight	14
20,5 Counterweight	19
12,9 Counterweight	24
8,6 Counterweight	29
4,3 Counterweight	32
Zero Counterweight	34

Manitowoc  
Crane Group

Truck Crane

## features

2



**A powerful superstructure on a powerful chassis makes this 90 US ton truck crane unbeatable on the road and on the jobsite.**



The superstructure features a full power five section MEGAFORM boom that can reach to a maximum tip height of 150 ft. The TWIN-LOCK boom pinning system provides pre-selection of boom extension modes to efficiently pin boom sections automatically.



A bi-fold swingaway lattice extension easily stows on the side of the base boom for easy transport. The choice of a manual or optional hydraulically offsettable extension is available. To take it even further, up to two additional extension inserts can be added to provide up to 237 ft. of tip height.



Two-stage inverted jack outriggers provide 3 position settings – 0%, 50% and 100%.



Front and rear air over walking beam suspension provides a smooth ride at 65 mph. Aluminum wheels, fenders and decking are also standard features.



Up to 31,500 lbs of counterweight can be power installed and removed from the superstructure cab, making transporting a breeze.



Crane functions are controlled by ECOS (Electronic Crane Operating System) with CAN-BUS. The EKS4 load moment indicator provides detailed feedback and control of the cranes operating functions. Electronically controlled ISM 450 diesel engine delivers plenty of power on and off the jobsite.



## specifications

### Superstructure

#### Boom

37 ft. - 142 ft. (11.2 m - 43.2 m) five section, full power boom with patented TWIN-LOCK™ boom pinning system. Maximum tip height: 150 ft. (45.8 m). Trailing Boom float kit

#### Boom Nose

Six nylatron sheaves, mounted on heavy duty tapered roller bearings with removable pin-type rope guards. Quick Reeve boom nose. Removable auxiliary boom nose with removable pin type rope guard.

#### Boom Elevation

Single lift cylinder with safety valve provides boom angle from -3° to +82°.

#### Offsettable Lattice Extension

33 ft. - 56 ft. (10 m - 17 m) bifold lattice swingaway extension manual offsettable from 0°, 20°, 40°. Maximum tip height: 204 ft (62.3 m)

#### \* Hydraulically Offsettable Lattice Extension

33 ft. - 56 ft. (10 m - 17 m) bifold lattice swingaway extension hydraulically offsettable and luffing under load from 5° - 40°. Controlled from the crane cab. Maximum tip height: 204 ft (62.3 m)

#### \* Lattice Jib Extensions

Two 16 ft. (5 m) inserts for use with lattice swingaway extension to increase length up to 72 ft. (22 m) or 88 ft. (27 m). Maximum tip height: 237 ft (72.2 m)

#### Load Moment & Anti-Two Block System

Load moment and anti-two block system with audio/visual warning and control lever lockout provides electronic display of boom angle, length, radius, tip height, relative load moment, maximum permissible load, load indication and warning of impending two-block condition.

#### Cab

All aluminum construction cab with acoustical lining is hydraulically tiltable (- 5° to +15°) and includes tinted safety glass, adjustable operator's seat with hydraulic suspension, sliding windows in side and cab rear, hinged front window with wiper, sunvisor and window shade. Other features include diesel heater/defroster, armrest integrated crane controls, and ergonomically arranged instrumentation.

#### Crane Control System

Full electronic control of all crane movements using electrical control levers with automatic reset to zero. Controls are integrated with the LMI and engine management system by CAN-BUS. ECOS system with graphic display.

#### Swing

Axial piston fixed displacement motor and planetary gear box. Infinitely variable to 1.7 rpm. Holding brake and service brake.

3

#### Counterweight

12,900 lbs. (5 851 kg) consisting of various sections with hydraulic installation/removal system controlled from the superstructure cab. An optional heavy counterweight package is available consisting of an additional 7,600 lbs and 11,000 lbs for a total of 31,500 lbs of counterweight.

#### Hydraulic System

2 separate circuits, 1 axial piston variable displacement pump (load sensing) with electronic power limiting control and 1 gear pump for swing. Combined capacity is 122.2 gpm (462 l/min) Dual thermostatically controlled oil coolers keep oil at optimum operating temperature. Tank capacity: 134 gal. (508 l)

#### Hoist

Main and auxiliary hoist are powered by axial piston motor with planetary gear and brake. "Thumbthumper" hoist drum rotation indicator alerts operator of hoist movement.

	Main	Auxiliary
Line length:	720 ft. (220 m)	720 ft. (220 m)
Rope diameter:	16 mm	16 mm
Line speed:	410 ft./min. (125 m/min)	410 ft./min. (125 m/min)
Line pull:	11,240 lbs. (50 kN)	11,240 lbs. (50 kN)

\*Denotes optional equipment

TMS900E

GROVE

## dimensions

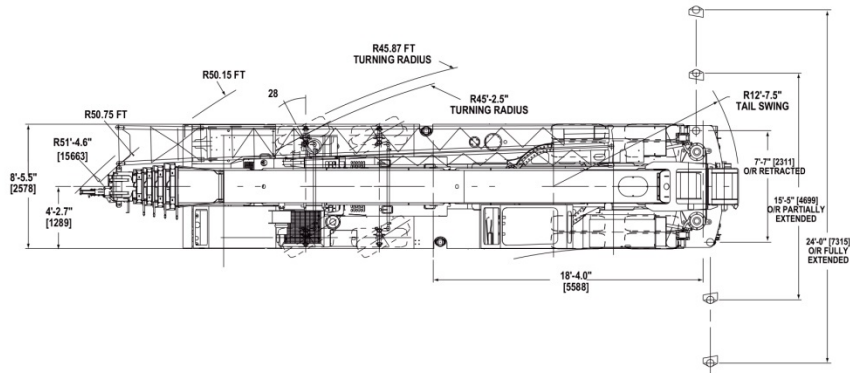

5

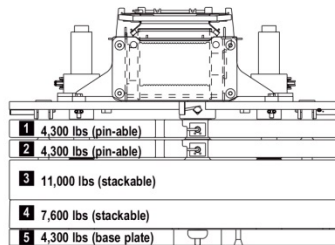
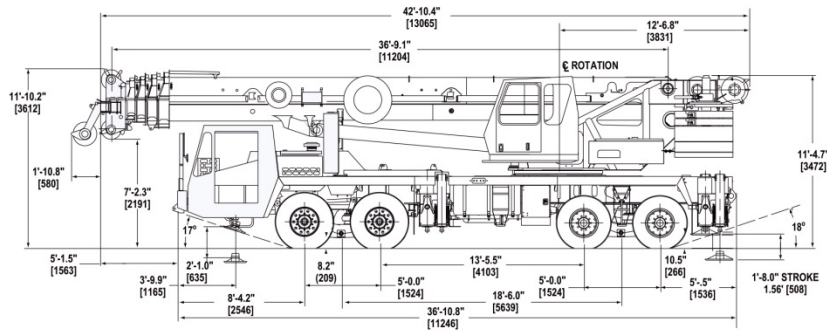

	1	2	3	4	5
Zero					
4,300 lbs	●				
8,600 lbs	●			●	
12,900 lbs	●	●		●	
20,500 lbs	●	●	●	●	
27,200 lbs	●	●	●	●	●
31,500 lbs	●	●	●	●	●

	Counterweight Configuration						
	31,500	27,200	20,500	12,900	8,600	4,300	0
Main Boom	✘	■	✘	■	✘	●	✘
33 ft. Swingaway	✘	■	✘	■	✘	●	✘
56 ft. Swingaway	✘	■	✘	■	✘	●	✘
72 ft. Swingaway	✘	■	✘	■	✘	●	✘
88 ft. Swingaway	✘	■	✘	■	✘	●	✘
Outrigger span-	100%: ✘	50%: ■	0%: ●				

TMS900E

GROVE

## dimensions

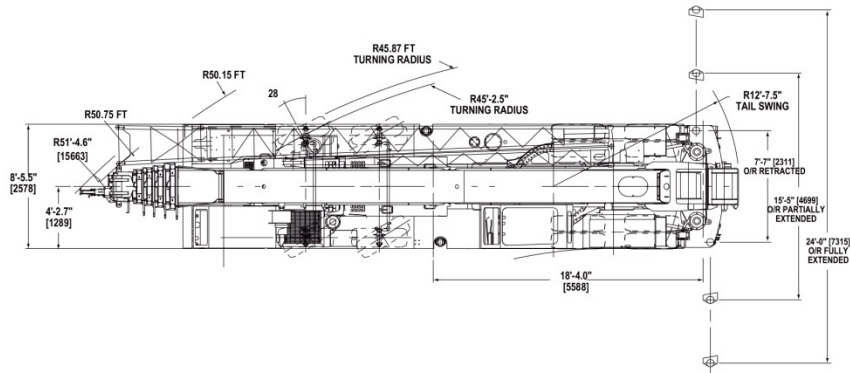

5

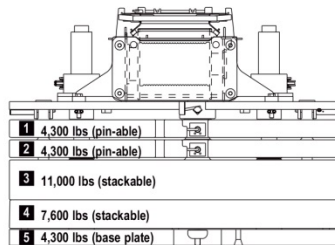
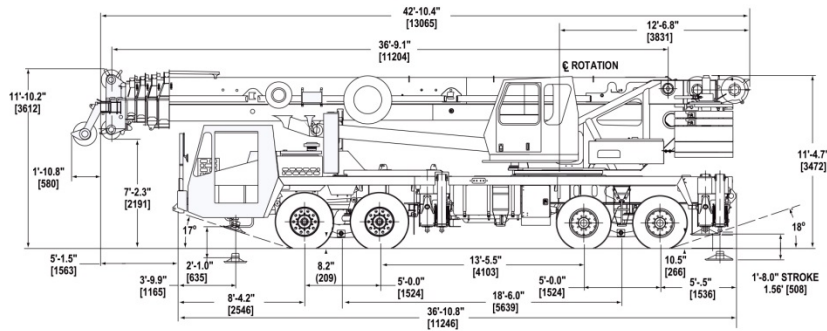

	1	2	3	4	5
Zero					
4,300 lbs	●				
8,600 lbs	●			●	
12,900 lbs	●	●		●	
20,500 lbs	●	●	●	●	
27,200 lbs	●	●	●	●	●
31,500 lbs	●	●	●	●	●

	Counterweight Configuration						
	31,500	27,200	20,500	12,900	8,600	4,300	0
Main Boom	✘	■	■	■	■	■	●
33 ft. Swingaway	✘	■	■	■	■	■	●
56 ft. Swingaway	✘	■	■	■	■	■	●
72 ft. Swingaway	✘	■	■	■	■	■	●
88 ft. Swingaway	✘	■	■	■	■	■	●
Outrigger span-	100%: ✘	50%: ■	0%: ●				

TMS900E

GROVE

## travel proposals

### Boom over front

6

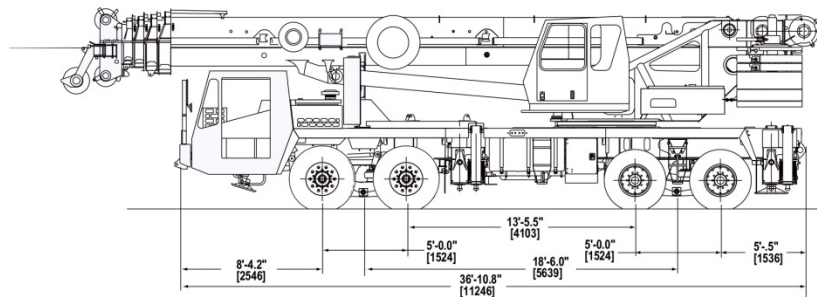

Unit equipped with:	Gross (lb.)	Front (lb.)	Rear (lb.)
Basic machine including 142 ft. main boom, main and auxiliary hoists with rope, no removable counterweight and driver.	79,943	39,461	40,482
Add 4,300 lb. slab on superstructure.	4,300	-1,295	5,595
Add 4,300 lb. (baseplate) on carrier front deck.	4,300	3,232	1,068
Add 7,600 lb. slab on carrier front deck.	7,600	5,712	1,888
Add manual offset swingaway.	2,890	2,920	-30
Add hydraulic luffing swingaway.	3,070	3,077	-7
Add 6 ton headache ball (stowed in front trough).	315	464	-149
Add 6 ton headache ball (stowed on rear chassis mount), includes mount weight.	375	-166	541
Add 55 ton hookblock (stowed in front trough).	1,500	2,127	-627

### Trailing boom dolly

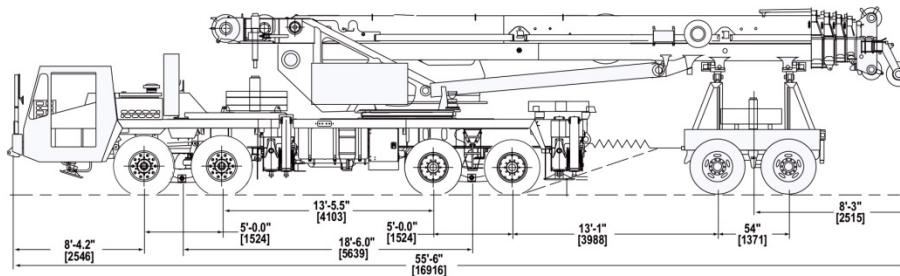

Unit equipped with:	Gross (lb.)	Front (lb.)	Rear (lb.)	Dolly (lb.)
Basic machine including 142 ft. main boom, main and auxiliary hoists with rope, hydraulic luffing bifold swingaway, no removable cwt, 6 ton headache ball (front chassis stowage), 55 ton hookblock (front chassis stowage), driver and 6,000 lb. split lower boom dolly.	90,858	37,321	31,232	22,306
Add (2) 4,300 lb. slabs to superstructure or front chassis storage, (1) 4,300 lb. slab on rear chassis storage, 7,600 lb. slab, 6 ton headache ball and 55 ton hookblock on dolly (20,500 lb. cwt).	111,358	39,899	39,738	31,721
Add (2) 4,300 lb. slabs to superstructure or front chassis storage, 7,600 lb. slab on rear chassis storage, (1) 4,300 lb. slab and 11,000 lb. slab on dolly, 6 ton headache ball and 55 ton hookblock on dolly (31,500 lb. cwt).	122,358	42,906	40,032	39,421

TMS900E

GROVE

## working range

37-142' main boom + 33-56' lattice extension

7

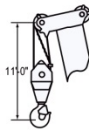
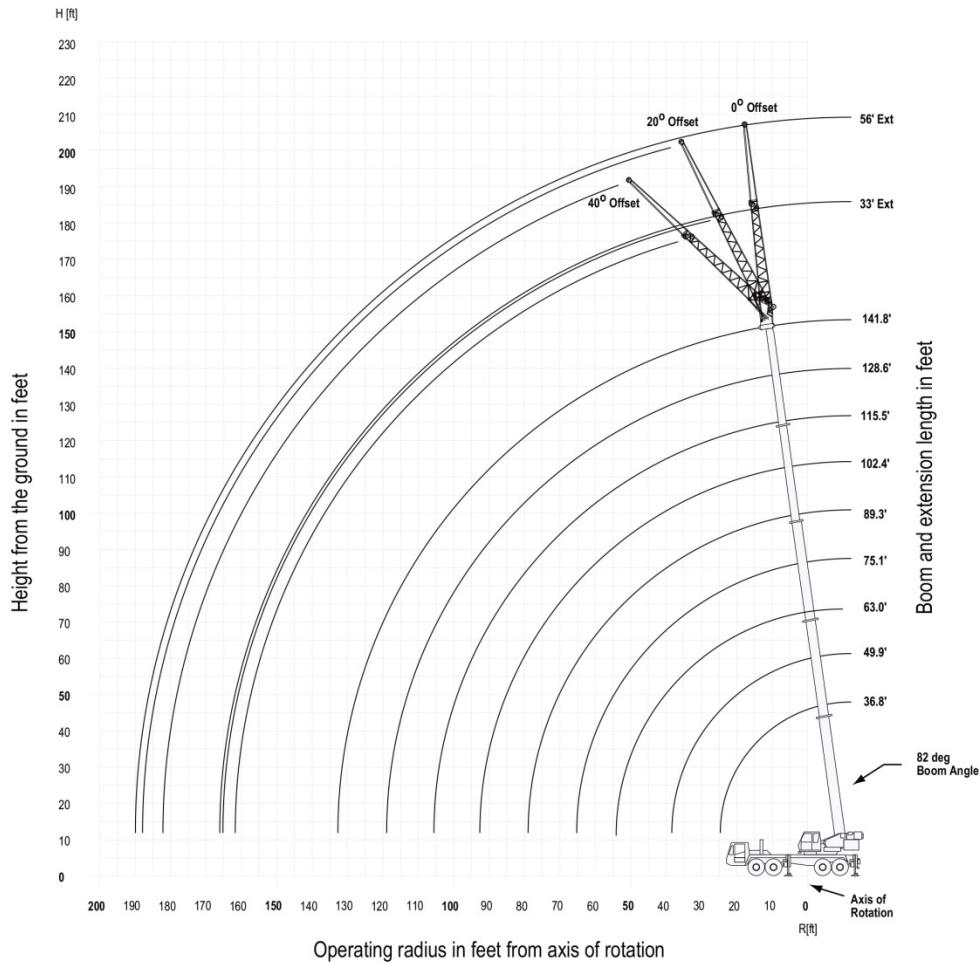

Dimensions are for largest Grove furnished hookblock and headache ball, with anti-two block activated.

TMS 900E

THIS CHART IS ONLY A GUIDE AND SHOULD NOT BE USED TO OPERATE THE CRANE. The individual crane's load chart, operating instructions and other instructional plates must be read and understood prior to operating the crane.

GROVE

## working range

33-56' lattice extension with 16' inserts

8

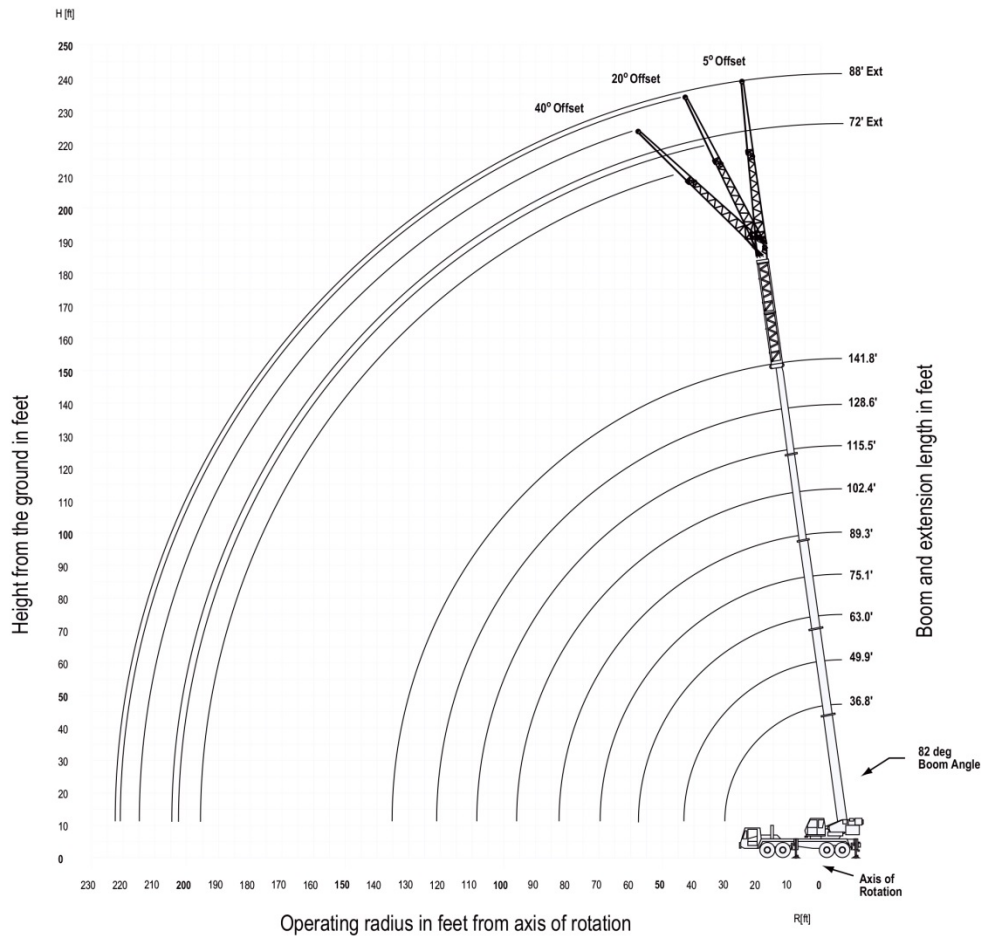

TMS900E

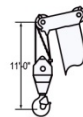

Dimensions are for largest Grove furnished hookblock and headache ball, with anti-two block activated

GROVE

THIS CHART IS ONLY A GUIDE AND SHOULD NOT BE USED TO OPERATE THE CRANE. The individual crane's load chart, operating instructions and other instructional plates must be read and understood prior to operating the crane.

## load charts

37 - 142 ft Fixed lengths  
31,500 lbs  
100% 24'-0"  
360

Pounds

Feet	36.8	49.9	63.0	76.1	89.3	102.4	115.5	128.6	141.8
8	180,000								
10	155,000	136,000	129,000	123,000	81,000				
15	116,000	112,000	105,000	99,000	81,000	59,000			
20	88,700	90,350	89,000	84,000	81,000	57,000	42,400	34,000	
25	69,950	72,200	72,400	71,150	71,000	51,000	42,400	34,000	26,600
30		56,350	57,000	58,150	56,950	46,000	39,800	33,800	26,600
35		46,600	47,550	47,400	46,200	41,600	35,800	32,000	26,600
40			39,750	39,600	38,450	38,200	32,200	29,400	26,600
45			33,550	33,500	32,600	33,600	29,400	27,000	24,800
50			28,300	28,300	29,400	28,600	26,600	24,800	22,800
55				24,250	25,350	24,600	24,800	22,800	21,200
60				22,000	22,150	21,450	21,750	20,300	19,800
65				19,550	19,550	19,400	19,100	18,800	18,200
70					17,300	17,600	16,900	16,750	16,200
75					15,400	15,750	15,200	14,900	14,350
80						14,100	13,750	13,350	12,750
85						12,700	12,350	11,950	11,400
90						11,500	11,150	10,850	10,300
95							10,100	9,770	9,250
100							9,140	8,810	8,290
105								7,950	7,430
110								7,180	6,670
115								6,480	5,980
120									5,340
125									4,760
130									4,230

\* Requires special equipment

37 - 142 ft Telescoping  
31,500 lbs  
100% 24'-0"  
360

Pounds

Feet	36.8 - 49.9	49.9 - 63.0	63.0 - 76.1	76.1 - 89.3	89.3 - 102.4	102.4 - 115.5	115.5 - 128.6	128.6 - 141.8
10	74,000	68,000	63,000	62,000				
15	72,000	65,000	60,000	57,000	54,000			
20	70,000	63,000	57,000	52,000	50,000	37,400	28,600	
25	67,000	59,000	55,000	50,000	46,000	37,400	28,600	22,400
30	55,000	55,000	53,000	48,000	41,600	34,000	28,600	20,800
35	45,000	46,000	47,400	46,000	37,800	31,000	27,400	18,800
40		38,850	39,600	38,450	34,600	28,200	25,400	16,800
45		33,200	33,500	32,600	31,800	26,000	23,200	15,200
50		28,300	28,300	27,750	28,600	24,000	21,200	14,000
55			24,250	23,750	24,600	22,600	19,800	12,800
60			21,050	22,150	21,450	20,800	18,400	11,800
65			18,600	19,550	18,800	19,100	17,000	10,800
70				17,300	16,650	16,900	16,000	10,200
75				15,400	15,550	15,050	14,900	9,600
80					13,950	13,450	13,350	9,000
85					12,700	12,100	11,950	8,400
90					11,500	10,900	10,850	8,000
95						9,850	9,770	7,600
100						8,890	8,810	7,200
105							7,950	6,800
110							7,180	6,400
115							6,480	5,980
120								5,340
125								4,760
130								4,230

TMS900E

THIS CHART IS ONLY A GUIDE AND SHOULD NOT BE USED TO OPERATE THE CRANE. The individual crane's load chart, operating instructions and other instructional plates must be read and understood prior to operating the crane.

GROVE

## load charts

10

89-142 ft 33 ft 31,500 lbs 100% 24'-0" 360

Pounds

Feet	33' Hydraulic Bifold Swingaway 5 Deg Fixed Offset Angle					33' Hydraulic Bifold Swingaway 40 Deg Fixed Offset Angle				
	89.3	102.4	115.5	128.6	141.8	89.3	102.4	115.5	128.6	141.8
20	22,000									
25	22,000	22,000								
30	22,000	22,000	22,000	17,800						
35	22,000	22,000	21,800	17,800	13,800					
40	22,000	22,000	21,400	17,800	13,800	14,000	14,200			
45	21,800	22,000	21,000	17,800	13,800	13,600	13,800	13,800		
50	19,800	21,000	20,400	17,800	13,800	13,200	13,400	13,600	13,600	11,400
55	18,400	19,400	19,800	17,200	13,800	12,800	13,000	13,200	13,200	11,400
60	17,400	18,200	18,600	16,600	13,800	12,400	12,600	12,800	13,000	11,400
65	16,400	17,200	17,200	15,800	13,800	12,000	12,200	12,400	12,800	11,400
70	15,800	16,150	15,900	15,000	13,800	11,800	11,800	12,000	12,600	11,400
75	14,800	14,300	14,050	14,000	13,000	11,400	11,600	11,800	12,200	11,400
80	13,550	12,850	12,400	12,600	12,000	11,200	11,400	11,600	11,800	11,400
85	12,100	11,250	11,100	11,250	11,200	11,200	11,200	11,400	11,400	11,200
90	10,950	10,100	9,800	10,400	10,400	11,000	10,750	10,650	10,900	10,800
95	9,880	9,200	9,000	9,600	9,340		9,550	9,460	9,800	10,100
100	9,000	8,600	8,200	8,950	8,380		8,800	8,600	9,400	9,060
105	8,600	8,200	7,800	8,090	7,510			8,200	8,580	8,120
110	8,310	7,800	7,400	7,310	6,730			7,600	7,730	7,270
115		7,560	7,000	6,600	6,020				6,950	6,490
120		6,920	6,410	5,950	5,370				6,240	5,780
125			5,820	5,360	4,780					5,130
130			5,280	4,820	4,250					4,530
135			4,790	4,320	3,750					
140				3,870	3,300					
145				3,450	2,880					
150				3,070	2,490					
155					2,130					
160					1,800					

TMS900E

89-142 ft 56 ft 31,500 lbs 100% 24'-0" 360

Pounds

Feet	56' Hydraulic Bifold Swingaway 5 Deg Fixed Offset Angle					56' Hydraulic Bifold Swingaway 40 Deg Fixed Offset Angle				
	89.3	102.4	115.5	128.6	141.8	89.3	102.4	115.5	128.6	141.8
30	11,000	11,000	11,000							
35	11,000	11,000	11,000	9,800						
40	11,000	11,000	11,000	9,800	8,200					
45	11,000	11,000	11,000	9,800	8,200					
50	11,000	11,000	11,000	9,800	8,200					
55	10,600	11,000	11,000	9,800	8,200	7,000	7,000			
60	10,200	10,600	10,800	9,800	8,200	6,800	6,800	7,000		
65	9,600	10,000	10,200	9,800	8,200	6,600	6,800	6,800		
70	9,200	9,600	9,800	9,600	8,200	6,400	6,600	6,600	6,600	
75	8,800	9,200	9,400	9,600	8,200	6,400	6,400	6,400	6,400	6,400
80	8,400	8,800	9,000	9,200	8,200	6,200	6,200	6,400	6,400	6,400
85	8,000	8,400	8,800	8,800	8,200	6,000	6,200	6,200	6,200	6,200
90	7,600	8,200	8,400	8,600	8,200	6,000	6,000	6,200	6,200	6,200
95	7,400	7,800	8,200	8,200	8,200	6,000	6,000	6,000	6,000	6,000
100	7,200	7,400	7,800	8,000	8,000	5,800	6,000	6,000	6,000	6,000
105	6,800	7,200	7,600	7,800	7,800	5,800	5,800	6,000	6,000	6,000
110	6,600	7,000	7,120	7,200	7,400	5,800	5,800	5,800	5,800	5,800
115	6,400	6,700	6,410	7,000	6,680		5,800	5,800	5,800	5,800
120	6,200	6,200	6,200	6,590	6,030		5,800	5,800	5,800	5,800
125	6,000	6,000	5,800	5,990	5,420			5,800	5,800	5,800
130	5,690	5,600	5,400	5,440	4,870			5,800	5,800	5,720
135		5,400	5,200	4,930	4,370				5,520	5,120
140		5,200	4,800	4,460	3,900				4,960	4,560
145			4,500	4,030	3,470					
150			4,090	3,630	3,070					4,040
155			3,720	3,250	2,690					3,560
160				2,910	2,350					
165				2,590	2,030					
170				2,290	1,720					
175					1,440					
180					1,180					

**GROVE**

THIS CHART IS ONLY A GUIDE AND SHOULD NOT BE USED TO OPERATE THE CRANE. The individual crane's load chart, operating instructions and other instructional plates must be read and understood prior to operating the crane.

## load charts

89-142 ft    72 ft (16+56 ft)    31,500 lbs    100% 24'-0"    360

Pounds

Feet	16' Insert + 56' Hydraulic Bi-Fold Swingaway Extension					16' Insert + 55.8' Hydraulic Bi-Fold Swingaway Extension				
	5 Deg Fixed Offset Angle					40 Deg Fixed Offset Angle				
	89.3	102.4	115.5	128.6	141.8	89.3	102.4	115.5	128.6	141.8
35	11,000									
40	11,000	10,800	9,800							
45	11,000	10,800	9,800	8,000						
50	11,000	10,600	9,800	8,000	6,600					
55	10,800	10,400	9,600	8,000	6,600					
60	10,200	10,200	9,600	8,000	6,600	6,800				
65	9,600	9,800	9,400	8,000	6,600	6,600				
70	9,200	9,400	9,200	8,000	6,600	6,600	6,600	6,600		
75	8,800	9,000	9,000	8,000	6,600	6,400	6,400	6,400	6,400	6,200
80	8,400	8,600	8,600	8,000	6,600	6,200	6,400	6,400	6,400	6,200
85	8,000	8,400	8,400	8,000	6,600	6,200	6,200	6,200	6,200	6,200
90	7,800	8,000	8,000	7,800	6,600	6,000	6,200	6,200	6,200	6,200
95	7,400	7,600	7,800	7,600	6,600	6,000	6,000	6,000	6,200	6,000
100	7,200	7,400	7,600	7,400	6,600	5,800	6,000	6,000	6,000	6,000
105	6,800	7,200	7,400	7,200	6,600	5,800	5,800	6,000	6,000	6,000
110	6,600	7,000	7,000	7,000	6,400	5,800	5,800	5,800	5,800	5,800
115	6,400	6,800	6,440	6,440	6,200	5,800	5,800	5,800	5,800	5,800
120	6,200	6,120	5,790	5,800	5,940	5,800	5,800	5,800	5,800	5,800
125	6,000	5,520	5,200	5,400	5,340	5,800	5,800	5,800	5,800	5,600
130	5,760	4,970	4,800	5,200	4,780		5,600	5,430	5,530	5,400
135	5,240	4,600	4,600	4,830	4,270		4,970	5,000	5,200	5,150
140	4,770	4,400	4,200	4,360	3,800			4,800	5,000	4,800
145	4,340	4,200	4,000	3,920	3,360			4,400	4,500	4,080
150	3,930	4,000	3,800	3,520	2,960				4,020	3,600
155		3,800	3,600	3,140	2,580				3,560	3,150
160		3,600	3,600	2,790	2,230					2,730
165			2,940	2,470	1,910					2,330
170			2,640	2,160	1,600					
175			2,350	1,880	1,320					
180				1,610	1,050					

11

89-142 ft    88 ft (32 + 56 ft)    31,500 lbs    100% 24'-0"    360

Pounds

Feet	32' Insert + 56' Hydraulic Bi-Fold Swingaway Extension					32' Insert + 56' Hydraulic Bi-Fold Swingaway Extension				
	5 Deg Fixed Offset Angle					40 Deg Fixed Offset Angle				
	89.3	102.4	115.5	128.6	141.8	89.3	102.4	115.5	128.6	141.8
40	9,600	9,200								
45	9,200	9,000	7,800							
50	9,000	8,600	7,800	6,400	5,000					
55	8,600	8,400	7,800	6,400	5,000					
60	8,200	8,200	7,600	6,400	5,000					
65	7,800	7,800	7,400	6,400	5,000					
70	7,400	7,600	7,200	6,400	5,000					
75	7,200	7,200	7,000	6,400	5,000	6,200	6,200			
80	6,800	7,000	6,800	6,400	5,000	6,000	6,000	6,000		
85	6,600	6,600	6,600	6,200	5,000	5,800	5,800	5,800	5,600	5,000
90	6,200	6,400	6,400	6,200	5,000	5,600	5,600	5,400	5,400	5,000
95	6,000	6,200	6,200	6,000	5,000	5,200	5,400	5,400	5,200	5,000
100	5,800	6,000	6,000	5,800	5,000	5,200	5,200	5,200	5,200	5,000
105	5,600	5,800	5,800	5,800	5,000	5,000	5,000	5,200	5,000	5,000
110	5,200	5,400	5,600	5,600	5,000	4,800	5,000	5,000	5,000	4,800
115	5,000	5,200	5,400	5,400	5,000	4,800	4,800	4,800	4,800	4,800
120	4,800	5,000	5,200	5,200	4,800	4,600	4,800	4,800	4,800	4,600
125	4,600	4,800	5,000	5,000	4,600	4,600	4,600	4,600	4,800	4,600
130	4,400	4,800	4,720	4,670	4,400	4,400	4,600	4,600	4,600	4,400
135	4,400	4,560	4,200	4,200	4,200	4,400	4,400	4,600	4,600	4,400
140	4,200	4,080	3,800	4,000	3,780	4,200	4,400	4,400	4,400	4,200
145	4,000	3,940	3,600	3,800	3,340		4,160	3,950	4,000	4,000
150	3,800	3,240	3,400	3,490	2,940		3,660	3,600	3,800	3,660
155	3,620	3,000	3,200	3,110	2,560			3,400	3,600	3,240
160	3,270	3,000	3,000	2,760	2,210			3,200	3,250	2,820
165		2,800	2,600	2,430	1,880				2,850	2,430
170		2,600	2,400	2,120	1,570				2,450	2,060
175		2,400	2,310	1,830	1,280					1,710
180			2,040	1,560	1,010					1,370
185			1,780	1,310						
190			1,550	1,070						

TMS900E

THIS CHART IS ONLY A GUIDE AND SHOULD NOT BE USED TO OPERATE THE CRANE. The individual crane's load chart, operating instructions and other instructional plates must be read and understood prior to operating the crane.

**GROVE**

## load charts

12

89-142 ft 33 ft 31,500 lbs 100% 24'-0" 360

Pounds

Feet	33' Manual Offset Bi-Fold Swingaway 0 Deg Fixed Offset Angle					33' Manual Offset Bi-Fold Swingaway 40 Deg Fixed Offset Angle				
	89.3	102.4	115.5	128.6	141.8	89.3	102.4	115.5	128.6	141.8
20	22,000									
25	22,000	22,000								
30	22,000	22,000	22,000	17,800						
35	22,000	22,000	21,800	17,800	13,600					
40	22,000	22,000	21,400	17,800	13,600	14,000	14,200			
45	21,600	22,000	21,000	17,800	13,600	13,600	13,800	13,800		
50	19,800	21,000	20,400	17,800	13,600	13,200	13,400	13,600	13,600	11,400
55	18,400	19,400	19,800	17,200	13,600	12,800	13,000	13,200	13,200	11,400
60	17,400	18,200	18,600	16,600	13,600	12,400	12,600	12,800	13,000	11,400
65	16,400	17,200	17,200	15,800	13,600	12,000	12,200	12,400	12,800	11,400
70	15,600	15,950	15,650	15,000	13,600	11,600	11,800	12,000	12,600	11,400
75	14,600	14,100	13,800	14,000	13,000	11,400	11,600	11,600	12,200	11,400
80	13,400	12,500	12,200	12,400	12,000	11,200	11,400	11,600	11,800	11,400
85	12,000	11,200	10,900	11,200	11,200	11,200	11,200	11,400	11,400	11,200
90	10,850	10,000	9,800	10,400	10,250	11,000	10,750	10,650	10,900	10,800
95	9,790	9,200	9,000	9,800	9,190		9,550	9,460	9,800	10,100
100	9,000	8,600	8,200	8,830	8,240		8,800	8,600	9,400	9,060
105	8,600	8,200	7,800	7,980	7,390			8,200	8,590	8,120
110	8,290	7,800	7,400	7,210	6,620			7,600	7,730	7,270
115		7,520	6,990	6,510	5,910				6,950	6,490
120		6,890	6,350	5,870	5,280				6,240	5,780
125			5,770	5,290	4,700					5,130
130			5,250	4,760	4,170					4,530
135			4,770	4,270	3,680					
140				3,830	3,230					
145				3,420	2,820					
150				3,050	2,450					
155					2,100					
160					1,770					

89-142 ft 56 ft 31,500 lbs 100% 24'-0" 360

Pounds

Feet	56' Manual Offset Bi-Fold Swingaway Extension 0 Deg Fixed Offset Angle					56' Manual Offset Bi-Fold Swingaway Extension 40 Deg Fixed Offset Angle				
	89.3	102.4	115.5	128.6	141.8	89.3	102.4	115.5	128.6	141.8
30	11,000	11,000	11,000							
35	11,000	11,000	11,000	9,800						
40	11,000	11,000	11,000	9,800	7,800					
45	11,000	11,000	11,000	9,800	7,800					
50	11,000	11,000	11,000	9,800	7,800					
55	10,600	11,000	11,000	9,800	7,800	7,000	7,000			
60	10,200	10,600	10,800	9,800	7,800	6,800	6,800	7,000		
65	9,800	10,000	10,200	9,800	7,800	6,500	6,500	6,800		
70	9,200	9,600	9,800	9,600	7,800	6,400	6,600	6,600		
75	8,800	9,200	9,400	9,600	7,800	6,400	6,400	6,400	6,400	
80	8,400	8,800	9,000	9,200	7,800	6,200	6,200	6,400	6,400	6,400
85	8,000	8,400	8,800	8,800	7,800	6,000	6,200	6,200	6,200	6,200
90	7,600	8,200	8,400	8,400	7,800	6,000	6,000	6,200	6,200	6,200
95	7,400	7,800	8,200	8,200	7,800	6,000	6,000	6,000	6,000	6,000
100	7,200	7,400	7,800	8,000	7,800	5,800	6,000	6,000	6,000	6,000
105	6,800	7,200	7,600	7,730	7,800	5,800	5,800	6,000	6,000	6,000
110	6,600	7,000	6,910	7,200	7,180	5,800	5,800	5,800	5,800	5,800
115	6,400	6,540	6,400	7,000	6,480		5,800	5,800	5,800	5,800
120	6,200	6,200	6,200	6,420	5,830		5,800	5,800	5,800	5,800
125	6,000	6,000	5,800	5,830	5,240			5,800	5,800	5,800
130	5,640	5,600	5,400	5,290	4,700			5,800	5,800	5,720
135		5,400	5,200	4,800	4,210				5,520	5,120
140		5,200	4,800	4,340	3,760				4,960	4,560
145			4,420	3,920	3,340					4,040
150			4,030	3,530	2,950					3,560
155			3,680	3,170	2,590					
160				2,840	2,250					
165				2,530	1,940					
170				2,250	1,650					
175					1,380					
180					1,130					

TMS900E

**GROVE**

THIS CHART IS ONLY A GUIDE AND SHOULD NOT BE USED TO OPERATE THE CRANE. The individual crane's load chart, operating instructions and other instructional plates must be read and understood prior to operating the crane.

## load charts

13

89-142 ft    72 ft (16 + 56 ft)    31,500 lbs    100% 24'-0"    360

Pounds

Feet	16' Insert + 56' Manual Offset Bifold Swingaway 0 Deg Fixed Offset Angle					16' Insert + 56' Manual Offset Bifold Swingaway 40 Deg Fixed Offset Angle				
	89.3	102.4	115.5	128.6	141.8	89.3	102.4	115.5	128.6	141.8
30	11,000									
35	11,000	11,000								
40	11,000	10,800	9,400	8,000						
45	11,000	10,800	9,400	8,000						
50	11,000	10,800	9,400	8,000	6,400					
55	10,800	10,400	9,400	8,000	6,400					
60	10,200	10,200	9,400	8,000	6,400	6,800				
65	9,600	9,800	9,400	8,000	6,400	6,600				
70	9,200	9,400	9,200	8,000	6,400	6,600	6,600	6,600		
75	8,800	9,000	9,000	8,000	6,400	6,400	6,400	6,400	6,400	6,200
80	8,400	8,600	8,600	8,000	6,400	6,200	6,400	6,400	6,400	6,200
85	8,000	8,400	8,400	8,000	6,400	6,200	6,200	6,200	6,200	6,200
90	7,800	8,000	8,000	7,800	6,400	6,000	6,200	6,200	6,200	6,200
95	7,400	7,600	7,800	7,600	6,400	6,000	6,000	6,000	6,200	6,000
100	7,200	7,400	7,600	7,400	6,400	5,800	6,000	6,000	6,000	6,000
105	6,800	7,200	7,400	7,200	6,400	5,800	5,800	6,000	6,000	6,000
110	6,600	7,000	6,940	6,920	6,400	5,800	5,800	5,800	5,800	5,800
115	6,400	6,590	6,230	6,220	6,200	5,800	5,800	5,800	5,800	5,800
120	6,200	5,950	5,590	5,800	5,730	5,800	5,800	5,800	5,800	5,800
125	6,000	5,370	5,200	5,400	5,140	5,800	5,800	5,800	5,800	5,600
130	5,650	4,820	4,800	5,180	4,590	5,600	5,430	5,530	5,530	5,400
135	5,150	4,600	4,600	4,680	4,100	4,970	5,000	5,200	5,200	5,150
140	4,700	4,400	4,200	4,220	3,640		4,800	5,000	5,000	4,600
145	4,280	4,200	4,000	3,800	3,210		4,400	4,500	4,500	4,080
150	3,900	4,000	3,800	3,400	2,820			4,020	3,800	3,600
155		3,800	3,800	3,040	2,460			3,560	3,150	3,150
160		3,600	3,200	2,700	2,120				2,730	2,730
165			2,880	2,380	1,800					
170			2,590	2,090	1,510					
175			2,330	1,810	1,230					
180				1,560						

89-142 ft    88 ft (32 + 56 ft)    31,500 lbs    100% 24'-0"    360

Pounds

Feet	32' Insert + 56' Manual Offset Bi-Fold Swingaway Extension 0 Deg Fixed Offset Angle				32' Insert + 56' Manual Offset Bi-Fold Swingaway Extension 40 Deg Fixed Offset Angle					
	89.3	102.4	115.5	128.6	141.8	89.3	102.4	115.5	128.6	141.8
35	10,000									
40	9,600	9,000	7,800							
45	9,200	9,000	7,800	6,400						
50	9,000	8,600	7,800	6,400	4,800					
55	8,600	8,400	7,800	6,400	4,800					
60	8,200	8,200	7,600	6,400	4,800					
65	7,800	7,800	7,400	6,400	4,800					
70	7,400	7,600	7,200	6,400	4,800	6,200	6,200			
75	7,200	7,200	7,000	6,400	4,800	6,000	6,000	6,000		
80	6,800	7,000	6,800	6,400	4,800	5,800	5,800	5,800	5,600	5,000
85	6,600	6,800	6,600	6,200	4,800	5,600	5,600	5,600	5,600	5,000
90	6,200	6,400	6,400	6,200	4,800	5,400	5,400	5,400	5,400	5,000
95	6,000	6,200	6,200	6,000	4,800	5,200	5,400	5,400	5,200	5,000
100	5,800	6,000	6,000	5,800	4,800	5,200	5,200	5,200	5,200	5,000
105	5,600	5,800	5,800	5,800	4,800	5,000	5,000	5,200	5,000	5,000
110	5,200	5,400	5,600	5,600	4,800	4,800	5,000	5,000	5,000	4,800
115	5,000	5,200	5,400	5,400	4,800	4,800	4,800	4,800	4,800	4,800
120	4,800	5,000	5,200	5,200	4,800	4,600	4,800	4,800	4,800	4,600
125	4,600	4,800	5,000	5,000	4,600	4,600	4,600	4,600	4,600	4,600
130	4,400	4,800	4,530	4,480	4,400	4,400	4,600	4,600	4,600	4,400
135	4,400	4,410	4,030	4,200	4,070	4,400	4,400	4,600	4,600	4,400
140	4,200	3,950	3,800	4,000	3,610	4,200	4,400	4,400	4,400	4,200
145	4,000	3,520	3,600	3,750	3,180	4,160	3,950	4,000	4,000	4,000
150	3,800	3,200	3,400	3,360	2,790	3,660	3,600	3,800	3,800	3,690
155	3,560	3,000	3,200	2,990	2,420		3,400	3,600	3,240	
160	3,220	3,000	3,000	2,650	2,080		3,200	3,250	2,820	
165		2,800	2,600	2,330	1,760			2,850	2,430	
170		2,600	2,400	2,030	1,460			2,480	2,060	
175		2,400	2,240	1,750	1,160				1,710	
180			1,980	1,490						1,370
185			1,740	1,240						
190			1,520	1,010						

TMS900E

THIS CHART IS ONLY A GUIDE AND SHOULD NOT BE USED TO OPERATE THE CRANE. The individual crane's load chart, operating instructions and other instructional plates must be read and understood prior to operating the crane.

**GROVE**

## load charts

14

37 - 142 ft Fixed lengths    27,200 lbs    100% 24'-0"    360

Pounds

Feet	36.8	49.9	63.0	76.1	89.3	102.4	115.5	128.6	141.8
10	155,000	136,000	129,000	123,000	81,000				
15	115,000	112,000	105,000	99,000	81,000	59,000			
20	87,400	89,050	89,000	84,000	81,000	57,000	42,400	34,000	
25	67,550	69,800	70,000	68,750	70,400	51,000	42,400	34,000	26,600
30		55,000	56,400	56,200	55,000	46,000	39,600	33,800	28,600
35		45,000	45,950	45,750	44,500	41,600	35,800	32,000	26,600
40			38,000	37,900	37,050	38,100	32,200	29,400	26,600
45			31,450	31,400	32,000	31,700	29,400	27,000	24,800
50			26,450	26,500	27,550	29,800	26,400	24,800	22,800
55				23,850	23,750	22,950	23,250	21,800	21,200
60				20,750	20,700	20,800	20,250	20,150	19,550
65				18,200	18,200	18,500	17,750	17,650	17,050
70					16,200	16,400	15,950	15,550	15,000
75						14,600	14,200	13,800	13,250
80							13,050	12,700	12,300
85							11,750	11,350	11,000
90							10,600	10,250	9,850
95								9,220	8,840
100								8,280	7,930
105									7,120
110									6,580
115									6,370
120									5,700
125									4,610
130									4,050
									3,550

\* Requires special equipment

89-142 ft    33 ft    27,200 lbs    100% 24'-0"    360

Pounds

Feet	33° Hydraulic Bi-Fold Swingaway 5 Deg Fixed Offset Angle				33° Hydraulic Bi-Fold Swingaway 40 Deg Fixed Offset Angle					
	89.3	102.4	115.5	128.6	141.8	89.3	102.4	115.5	128.6	141.8
20	22,000									
25	22,000	22,000								
30	22,000	22,000	22,000	17,800						
35	22,000	22,000	21,800	17,800	13,800					
40	22,000	22,000	21,400	17,800	13,800	14,000	14,200			
45	21,800	22,000	21,000	17,800	13,800	13,600	13,800	13,800	13,600	11,400
50	19,800	21,000	20,400	17,800	13,800	13,200	13,400	13,600	13,600	11,400
55	18,400	19,400	19,800	17,200	13,800	12,800	13,000	13,200	13,200	11,400
60	17,400	18,200	18,600	16,600	13,800	12,400	12,600	12,800	13,000	11,400
65	16,400	17,100	16,850	15,800	13,800	12,000	12,200	12,400	12,800	11,400
70	15,600	14,950	14,700	14,900	13,800	11,600	11,800	12,000	12,600	11,400
75	14,050	13,150	12,900	13,100	13,000	11,400	11,600	11,600	12,200	11,400
80	12,500	11,600	11,400	12,000	11,900	11,200	11,400	11,600	11,800	11,400
85	11,200	10,800	10,600	11,200	10,650	11,200	11,100	11,000	11,250	11,200
90	10,200	10,000	9,800	10,050	9,490	10,450	9,820	9,800	10,200	10,350
95	9,600	9,200	9,000	9,030	8,440		9,200	9,200	9,690	9,220
100	9,000	8,600	8,200	8,090	7,500		8,800	8,800	8,670	8,200
105	8,270	8,200	7,730	7,250	6,670			8,110	7,750	7,290
110	7,520	7,480	6,970	6,500	5,920			7,270	6,930	6,470
115		6,800	6,290	5,830	5,250				6,180	5,720
120		6,190	5,680	5,210	4,640				5,500	5,040
125			5,120	4,650	4,080					4,420
130			4,610	4,140	3,570					3,850
135				3,680	3,110					
140					3,250					
145					2,850					
150					2,490					
155										
160										

TMS900E

**GROVE**

THIS CHART IS ONLY A GUIDE AND SHOULD NOT BE USED TO OPERATE THE CRANE. The individual crane's load chart, operating instructions and other instructional plates must be read and understood prior to operating the crane.

## load charts

89-142 ft    56 ft    27,200 lbs    100% 24'-0"    360

**15**

Feet    Pounds

Feet	56' Hydraulic Bi-Fold Swingaway 5 Deg Fixed Offset Angle					56' Hydraulic Bi-Fold Swingaway 40 Deg Fixed Offset Angle				
	89.3	102.4	115.5	128.6	141.8	89.3	102.4	115.5	128.6	141.8
30	11,000	11,000	11,000							
35	11,000	11,000	11,000	9,800						
40	11,000	11,000	11,000	9,800	8,200					
45	11,000	11,000	11,000	9,800	8,200					
50	11,000	11,000	11,000	9,800	8,200					
55	10,600	11,000	11,000	9,800	8,200	7,000	7,000			
60	10,200	10,600	10,800	9,800	8,200	6,800	6,800	7,000		
65	9,600	10,000	10,200	9,800	8,200	6,600	6,800	6,800		
70	9,200	9,600	9,800	9,600	8,200	6,400	6,600	6,600	6,600	
75	8,800	9,200	9,400	9,600	8,200	6,400	6,400	6,400	6,400	6,400
80	8,400	8,800	9,000	9,200	8,200	6,200	6,200	6,400	6,400	6,400
85	8,000	8,400	8,800	8,800	8,200	6,000	6,200	6,200	6,200	6,200
90	7,600	8,200	8,400	8,600	8,200	6,000	6,000	6,200	6,200	6,200
95	7,400	7,800	8,200	8,200	8,200	6,000	6,000	6,000	6,000	6,000
100	7,200	7,400	7,800	8,000	8,000	5,800	6,000	6,000	6,000	6,000
105	6,800	7,200	7,200	7,600	7,380	5,800	5,800	6,000	6,000	6,000
110	6,600	6,800	6,800	7,180	6,610	5,800	5,800	5,800	5,800	5,800
115	6,400	6,400	6,400	6,490	5,920	5,800	5,800	5,800	5,800	5,800
120	6,120	6,200	6,200	5,860	5,290	5,800	5,800	5,800	5,800	5,800
125	5,800	6,000	5,760	5,290	4,720		5,800	5,800	5,800	5,660
130	5,600	5,600	5,240	4,760	4,200		5,750	5,450	5,040	
135		5,260	4,750	4,280	3,720			4,870	4,470	
140		4,810	4,310	3,840	3,280			4,330	3,940	
145			3,900	3,430	2,870				3,450	
150			3,520	3,050	2,490				2,980	
155			3,170	2,700	2,140					
160				2,370	1,810					
165				2,070	1,510					
170				1,780	1,220					

89-142 ft    72 ft (16+56 ft)    27,200 lbs    100% 24'-0"    360

**TMS900E**

Feet    Pounds

Feet	16' Insert + 56' Hydraulic Bi-Fold Swingaway Extension 5 Deg Fixed Offset Angle					16' Insert + 56' Hydraulic Bi-Fold Swingaway Extension 40 Deg Fixed Offset Angle				
	89.3	102.4	115.5	128.6	141.8	89.3	102.4	115.5	128.6	141.8
35	11,000									
40	11,000	10,800	9,800							
45	11,000	10,800	9,800	8,000						
50	11,000	10,600	9,800	8,000	6,600					
55	10,600	10,400	9,600	8,000	6,600					
60	10,200	10,200	9,600	8,000	6,600	6,800				
65	9,600	9,800	9,400	8,000	6,600	6,600				
70	9,200	9,400	9,200	8,000	6,600	6,600	6,600	6,600		
75	8,800	9,000	9,000	8,000	6,600	6,400	6,400	6,400	6,400	6,200
80	8,400	8,600	8,600	8,000	6,600	6,200	6,400	6,400	6,400	6,200
85	8,000	8,400	8,400	8,000	6,600	6,200	6,200	6,200	6,200	6,200
90	7,800	8,000	8,000	7,800	6,600	6,000	6,200	6,200	6,200	6,200
95	7,400	7,600	7,600	7,600	6,600	6,000	6,000	6,000	6,200	6,000
100	7,200	7,400	7,600	7,400	6,600	5,800	6,000	6,000	6,000	6,000
105	6,800	7,200	7,160	7,160	6,600	5,800	5,800	6,000	6,000	6,000
110	6,600	6,730	6,390	6,380	6,400	5,800	5,800	5,800	5,800	5,800
115	6,400	6,030	5,800	6,000	5,840	5,800	5,800	5,800	5,800	5,800
120	6,190	5,400	5,400	5,780	5,210	5,800	5,800	5,800	5,800	5,800
125	5,610	5,000	5,200	5,200	4,630	5,800	5,570	5,390	5,490	5,600
130	5,080	4,800	4,800	4,670	4,110		4,930	5,200	5,200	5,080
135	4,600	4,600	4,600	4,190	3,620		4,800	5,000	4,920	4,500
140	4,150	4,400	4,200	3,740	3,180			4,730	4,390	3,970
145	4,000	4,200	3,800	3,330	2,770			4,230	3,900	3,480
150	3,800	3,930	3,420	2,940	2,380				3,440	3,020
155		3,570	3,060	2,590	2,030				3,010	2,600
160		3,240	2,730	2,260	1,700					2,190
165			2,420	1,950	1,390					1,810
170			2,130	1,660	1,100					
175			1,870	1,390						
180				1,140						

THIS CHART IS ONLY A GUIDE AND SHOULD NOT BE USED TO OPERATE THE CRANE. The individual crane's load chart, operating instructions and other instructional plates must be read and understood prior to operating the crane.

**GROVE**

## load charts

16

89-142 ft    88 ft (32 + 56 ft)    27,200 lbs    100% 24'-0"    360

Pounds

Feet	32' Insert + 56' Hydraulic Bi-Fold Swingaway Extension 5 Deg Fixed Offset Angle					32' Insert + 56' Hydraulic Bi-Fold Swingaway Extension 40 Deg Fixed Offset Angle				
	89.3	102.4	115.5	128.6	141.8	89.3	102.4	115.5	128.6	141.8
40	9,600	9,200								
45	9,200	9,000	7,800							
50	9,000	8,600	7,800	6,400	5,000					
55	8,600	8,400	7,800	6,400	5,000					
60	8,200	8,200	7,600	6,400	5,000					
65	7,800	7,800	7,400	6,400	5,000					
70	7,400	7,600	7,200	6,400	5,000	6,200	6,200			
75	7,200	7,200	7,000	6,400	5,000	6,000	6,000	6,000		
80	6,800	7,000	6,800	6,400	5,000	5,800	5,800	5,800	5,600	5,000
85	6,600	6,600	6,600	6,200	5,000	5,600	5,600	5,600	5,600	5,000
90	6,200	6,400	6,400	6,200	5,000	5,400	5,400	5,400	5,400	5,000
95	6,000	6,200	6,200	6,000	5,000	5,200	5,400	5,400	5,200	5,000
100	5,800	6,000	6,000	5,800	5,000	5,200	5,200	5,200	5,200	5,000
105	5,600	5,800	5,800	5,800	5,000	5,000	5,000	5,200	5,000	5,000
110	5,200	5,400	5,600	5,800	5,000	4,800	5,000	5,000	5,000	4,800
115	5,000	5,200	5,400	5,400	5,000	4,800	4,800	4,800	4,800	4,800
120	4,800	5,000	5,150	5,110	4,800	4,600	4,800	4,800	4,800	4,600
125	4,600	4,800	4,570	4,600	4,600	4,600	4,600	4,600	4,800	4,600
130	4,400	4,400	4,200	4,400	4,100	4,400	4,600	4,600	4,600	4,400
135	4,400	3,910	4,000	4,170	3,610	4,400	4,400	4,390	4,430	4,400
140	4,200	3,600	3,800	3,720	3,160	4,200	4,070	4,000	4,000	4,060
145	3,810	3,400	3,600	3,300	2,750		3,600	3,800	3,990	3,570
150	3,430	3,200	3,390	2,910	2,360		3,400	3,600	3,540	3,110
155	3,070	3,000	3,030	2,560	2,000			3,400	3,110	2,680
160	2,740	3,000	2,700	2,220	1,670			3,050	2,710	2,280
165		2,800	2,390	1,910	1,360				2,330	1,910
170		2,600	2,090	1,620	1,070				1,980	1,550
175		2,330	1,820	1,350						1,220
180			1,560	1,090						
185			1,330							
190			1,100							

89-142 ft    33 ft    27,200 lbs    100% 24'-0"    360

Pounds

Feet	33' Manual Offset Bi-Fold Swingaway 0 Deg Fixed Offset Angle					33' Manual Offset Bi-Fold Swingaway 40 Deg Fixed Offset Angle				
	89.3	102.4	115.5	128.6	141.8	89.3	102.4	115.5	128.6	141.8
20	22,000	22,000								
25	22,000	22,000	22,000							
30	22,000	22,000	22,000	17,400	13,600					
35	22,000	22,000	21,800	17,400	13,600					
40	22,000	22,000	21,400	17,400	13,600	14,000	14,200			
45	21,600	22,000	21,000	17,400	13,600	13,600	13,800	13,800		
50	19,800	21,000	20,400	17,400	13,600	13,200	13,400	13,600	13,600	11,400
55	18,400	19,400	19,800	17,200	13,600	12,800	13,000	13,200	13,200	11,400
60	17,400	18,200	18,600	16,600	13,600	12,400	12,600	12,800	13,000	11,400
65	16,400	16,850	16,500	15,800	13,600	12,000	12,200	12,400	12,800	11,400
70	15,600	14,750	14,450	14,650	13,600	11,600	11,800	12,000	12,600	11,400
75	13,850	12,950	12,700	12,850	13,000	11,400	11,600	11,600	12,200	11,400
80	12,350	11,600	11,400	12,000	11,700	11,200	11,400	11,600	11,800	11,400
85	11,100	10,800	10,600	11,100	10,500	11,200	11,100	11,000	11,250	11,200
90	10,200	10,000	9,800	9,950	9,320	10,450	9,820	9,800	10,200	10,350
95	9,800	9,200	9,000	8,890	8,280		9,200	9,200	9,890	9,220
100	9,000	8,600	8,200	7,970	7,360		8,800	8,600	8,670	8,200
105	8,220	8,160	7,630	7,140	6,540			8,110	7,750	7,290
110	7,500	7,420	6,890	6,400	5,810			7,270	6,930	6,470
115		6,750	6,220	5,740	5,140				6,180	5,720
120		6,150	5,620	5,130	4,540				5,500	5,040
125			5,070	4,580	3,990					4,420
130			4,570	4,080	3,490					3,850
135			4,120	3,630	3,030					
140				3,210	2,610					
145				2,820	2,230					
150				2,480	1,870					
155					1,540					
160					1,240					

TMS900E

**GROVE**

THIS CHART IS ONLY A GUIDE AND SHOULD NOT BE USED TO OPERATE THE CRANE. The individual crane's load chart, operating instructions and other instructional plates must be read and understood prior to operating the crane.

## load charts

89-142 ft    56 ft    27,200 lbs    100% 24'-0"    360

Pounds

Feet	56' Manual Offset Bi-Fold Swingaway Extension 0 Deg Fixed Offset Angle					56' Manual Offset Bi-Fold Swingaway Extension 40 Deg Fixed Offset Angle				
	89.3	102.4	115.5	128.6	141.8	89.3	102.4	115.5	128.6	141.8
25	11,000									
30	11,000	11,000			9,800					
35	11,000	11,000	11,000		9,800	7,800				
40	11,000	11,000	11,000	11,000	9,800	7,800				
45	11,000	11,000	11,000	9,800	7,800					
50	11,000	11,000	11,000	9,800	7,800					
55	10,600	11,000	11,000	9,800	7,800					
60	10,200	10,600	10,800	9,800	7,800	7,000	7,000			
65	9,600	10,000	10,200	9,800	7,800	6,800	6,800	7,000		
70	9,200	9,600	9,800	9,600	7,800	6,400	6,600	6,600	6,600	
75	8,800	9,200	9,400	9,600	7,800	6,400	6,400	6,400	6,400	6,400
80	8,400	8,800	9,000	9,200	7,800	6,200	6,200	6,400	6,400	6,400
85	8,000	8,400	8,800	8,800	7,800	6,000	6,200	6,200	6,200	6,200
90	7,600	8,200	8,400	8,600	7,800	6,000	6,000	6,200	6,200	6,200
95	7,400	7,800	8,200	8,200	7,800	6,000	6,000	6,000	6,000	6,000
100	7,200	7,400	7,800	7,800	7,800	5,800	6,000	6,000	6,000	6,000
105	6,800	7,190	7,200	7,600	7,130	5,800	5,800	6,000	6,000	6,000
110	6,600	6,800	6,800	6,980	6,380	5,800	5,800	5,800	5,800	5,800
115	6,400	6,400	6,400	6,300	5,710	5,800	5,800	5,800	5,800	5,800
120	6,010	6,200	6,190	5,690	5,100	5,800	5,800	5,800	5,800	5,800
125	5,800	6,000	5,630	5,130	4,540	5,800	5,800	5,800	5,800	5,800
130	5,600	5,600	5,120	4,620	1,030	5,750	5,750	5,450	5,450	5,040
135		5,190	4,650	4,150	3,560			4,870	4,870	4,470
140		4,760	4,220	3,720	3,130			4,430	4,430	3,940
145			3,820	3,320	2,740					3,450
150			3,460	2,960	2,370					2,960
155			3,120	2,620	2,030					
160				2,300	1,720					
165				2,010	1,420					
170				1,750	1,150					
175										
180										

17

89-142 ft    72 ft (16 + 56 ft)    27,200 lbs    100% 24'-0"    360

Pounds

Feet	16' Insert + 56' Manual Offset Bifold Swingaway 0 Deg Fixed Offset Angle				16' Insert + 56' Manual Offset Bifold Swingaway 40 Deg Fixed Offset Angle					
	89.3	102.4	115.5	128.6	141.8	89.3	102.4	115.5	128.6	141.8
30	11,000									
35	11,000	11,000								
40	11,000	10,800	9,400	8,000						
45	11,000	10,800	9,400	8,000	6,400					
50	11,000	10,600	9,400	8,000	6,400					
55	10,600	10,400	9,400	8,000	6,400					
60	10,200	10,200	9,400	8,000	6,400	6,800				
65	9,600	9,800	9,400	8,000	6,400	6,600				
70	9,200	9,400	9,200	8,000	6,400	6,600	6,600			
75	8,800	9,000	9,000	8,000	6,400	6,400	6,400	6,400	6,400	6,200
80	8,400	8,600	8,600	8,000	6,400	6,200	6,400	6,400	6,400	6,200
85	8,000	8,400	8,400	8,000	6,400	6,200	6,200	6,200	6,200	6,200
90	7,800	8,000	8,000	7,800	6,400	6,000	6,200	6,200	6,200	6,200
95	7,400	7,800	7,800	7,600	6,400	6,000	6,000	6,000	6,200	6,000
100	7,200	7,400	7,600	7,400	6,400	5,800	6,000	6,000	6,000	6,000
105	6,800	7,200	6,900	6,890	6,400	5,800	5,800	6,000	6,000	6,000
110	6,600	6,520	6,150	6,200	6,290	5,800	5,800	5,800	5,800	5,800
115	6,400	5,840	5,800	6,000	5,610	5,800	5,800	5,800	5,800	5,800
120	6,050	5,220	5,400	5,590	5,000	5,800	5,800	5,800	5,800	5,800
125	5,490	5,000	5,200	5,020	4,430	5,800	5,570	5,390	5,490	5,600
130	4,980	4,800	4,800	4,510	3,920		4,930	5,200	5,200	5,080
135	4,510	4,600	4,540	4,030	3,450		4,800	5,000	4,920	4,500
140	4,080	4,400	4,100	3,600	3,020			4,730	4,390	3,970
145	4,000	4,200	3,700	3,200	2,620			4,230	3,900	3,480
150	3,800	3,860	3,330	2,830	2,240				3,440	3,020
155		3,520	2,980	2,480	1,900				3,010	2,600
160		3,210	2,660	2,160	1,580					2,190
165			2,360	1,860	1,280					
170			2,090	1,590	1,000					
175			1,840	1,330						
180				1,090						

TMS900E

THIS CHART IS ONLY A GUIDE AND SHOULD NOT BE USED TO OPERATE THE CRANE. The individual crane's load chart, operating instructions and other instructional plates must be read and understood prior to operating the crane.

**GROVE**

## load charts

18

89-142 ft    88 ft (32 + 56 ft)    27,200 lbs    100% 24'-0"    360

Ⓢ Pounds

Feet	32' Insert + 56' Manual Offset Bi-Fold Swingaway Extension 0 Deg Fixed Offset Angle					32' Insert + 56' Manual Offset Bi-Fold Swingaway Extension 40 Deg Fixed Offset Angle				
	89.3	102.4	115.5	128.6	141.8	89.3	102.4	115.5	128.6	141.8
35	10,000									
40	9,600	9,000	7,800							
45	9,200	9,000	7,800	6,400						
50	9,000	8,600	7,800	6,400	4,800					
55	8,600	8,400	7,800	6,400	4,800					
60	8,200	8,200	7,600	6,400	4,800					
65	7,900	7,800	7,400	6,400	4,800					
70	7,400	7,600	7,200	6,400	4,800	6,200	6,200			
75	7,200	7,200	7,000	6,400	4,800	6,000	6,000	6,000		
80	6,800	7,000	6,800	6,400	4,800	5,800	5,800	5,800	5,600	5,000
85	6,600	6,600	6,600	6,200	4,800	5,600	5,600	5,600	5,400	5,000
90	6,200	6,400	6,400	6,200	4,800	5,400	5,400	5,400	5,400	5,000
95	6,000	6,200	6,200	6,000	4,800	5,200	5,400	5,400	5,200	5,000
100	5,800	6,000	6,000	5,800	4,800	5,200	5,200	5,200	5,200	5,000
105	5,600	5,800	5,800	5,800	4,800	5,000	5,000	5,200	5,000	5,000
110	5,200	5,400	5,600	5,600	4,800	4,800	5,000	5,000	5,000	4,800
115	5,000	5,200	5,400	5,400	4,800	4,800	4,800	4,800	4,800	4,800
120	4,800	5,000	4,940	4,880	4,800	4,600	4,800	4,800	4,800	4,600
125	4,600	4,760	4,400	4,600	4,420	4,600	4,600	4,600	4,800	4,600
130	4,400	4,240	4,200	4,400	3,900	4,400	4,600	4,600	4,600	4,400
135	4,400	3,800	4,000	4,000	3,430	4,400	4,400	4,390	4,430	4,400
140	4,120	3,600	3,800	3,560	2,990	4,200	4,070	4,000	4,000	4,060
145	3,720	3,400	3,600	3,160	2,580		3,600	3,800	3,990	3,570
150	3,350	3,200	3,280	2,780	2,210		3,400	3,600	3,540	3,110
155	3,000	3,000	2,930	2,430	1,860			3,400	3,110	2,880
160	2,690	3,000	2,600	2,110	1,540			3,050	2,710	2,280
165		2,800	2,300	1,810	1,240				2,330	1,910
170		2,550	2,020	1,530					1,980	1,550
175		2,290	1,760	1,260						1,220
180			1,510	1,010						
185			1,280							
190			1,070							

TMS900E

GROVE

THIS CHART IS ONLY A GUIDE AND SHOULD NOT BE USED TO OPERATE THE CRANE. The individual crane's load chart, operating instructions and other instructional plates must be read and understood prior to operating the crane.

## load charts

37 - 142 ft Fixed lengths 20,500 lbs 100% 24'-0" 360

Pounds

Feet	36.8	49.9	63.0	76.1	89.3	102.4	115.5	128.6	141.8
10	155,000	136,000	129,000	123,000	81,000				
15	112,500	112,000	105,000	99,000	81,000	59,000			
20	85,400	87,050	87,250	84,000	81,000	57,000	42,400	34,000	
25	62,750	64,950	65,150	66,850	65,600	51,000	42,400	34,000	26,600
30		50,550	52,800	52,350	51,100	46,000	39,600	33,800	26,600
35		40,450	42,650	42,500	41,300	41,600	35,800	32,000	26,600
40			34,200	34,100	35,000	34,400	32,200	29,400	26,600
45			28,200	28,600	29,250	28,450	28,600	27,000	24,800
50			23,800	24,900	24,750	24,200	24,250	23,200	22,800
55				21,350	21,250	21,550	20,800	20,700	20,100
60				18,500	18,600	18,750	18,300	17,850	17,250
65				16,150	16,250	16,350	15,900	15,450	14,900
70					14,250	14,400	13,950	13,500	12,950
75					12,600	12,700	12,300	11,850	11,300
80						11,300	10,950	10,550	9,990
85						10,100	9,730	9,330	8,780
90						9,040	8,670	8,280	7,730
95							7,720	7,350	6,800
100							6,880	6,530	5,980
105								5,790	5,250
110								5,110	4,560
115								4,500	4,000
120									3,460
125									2,960
130									2,510

19

89-142 ft 33 ft 20,500 lbs 100% 24'-0" 360

Pounds

Feet	33' Hydraulic Bi-Fold Swingaway 5 Deg Fixed Offset Angle					33' Hydraulic Bi-Fold Swingaway 40 Deg Fixed Offset Angle				
	89.3	102.4	115.5	128.6	141.8	89.3	102.4	115.5	128.6	141.8
20	22,000									
25	22,000	22,000								
30	22,000	22,000	22,000							
35	22,000	22,000	21,800	17,800	13,800					
40	22,000	22,000	21,400	17,800	13,800					
45	21,600	22,000	21,000	17,800	13,800	13,600	13,800	13,800		
50	19,800	21,000	20,400	17,800	13,800	13,200	13,400	13,600	13,600	11,400
55	18,400	19,400	19,800	17,200	13,800	12,800	13,000	13,200	13,200	11,400
60	17,400	17,350	17,100	16,600	13,800	12,400	12,600	12,800	13,000	11,400
65	15,900	15,000	14,700	14,900	13,800	12,000	12,200	12,400	12,800	11,400
70	13,850	13,200	13,200	13,600	13,250	11,600	11,800	12,000	12,600	11,400
75	12,400	12,400	12,400	12,200	11,550	11,400	11,600	11,600	12,200	11,400
80	11,800	11,600	11,250	10,850	10,250	11,200	10,800	10,800	11,000	11,250
85	10,800	10,600	10,050	9,590	9,000	10,200	10,200	10,200	10,450	9,980
90	9,530	9,500	8,990	8,500	7,910	9,800	9,800	9,630	9,260	8,790
95	8,560	8,530	8,020	7,540	6,950	8,930	8,930	8,570	8,200	7,730
100	7,700	7,670	7,160	6,680	6,100	7,980	7,620	7,260	6,790	
105	6,940	6,900	6,400	5,920	5,340		6,780	6,420	5,960	
110	6,260	6,210	5,710	5,240	4,660		6,010	5,670	5,200	
115		5,600	5,090	4,620	4,050			4,980	4,520	
120		5,040	4,530	4,070	3,490			4,350	3,900	
125			4,020	3,560	2,990				3,330	
130			3,560	3,100	2,520				2,800	
135			3,140	2,670	2,100					
140				2,280	1,710					
145				1,920	1,350					
150				1,600	1,020					
155										
160										

TMS900E

THIS CHART IS ONLY A GUIDE AND SHOULD NOT BE USED TO OPERATE THE CRANE. The individual crane's load chart, operating instructions and other instructional plates must be read and understood prior to operating the crane.

**GROVE**

## load charts

20

		89-142 ft					56 ft					20,500 lbs					100% 24'-0"					360				
		56' Hydraulic Bi-Fold Swingaway										56' Hydraulic Bi-Fold Swingaway														
		5 Deg Fixed Offset Angle					40 Deg Fixed Offset Angle					5 Deg Fixed Offset Angle					40 Deg Fixed Offset Angle									
Feet		89.3	102.4	115.5	128.6	141.8	89.3	102.4	115.5	128.6	141.8	89.3	102.4	115.5	128.6	141.8	89.3	102.4	115.5	128.6	141.8					
30		11,000	11,000	11,000																						
35		11,000	11,000	11,000		9,800																				
40		11,000	11,000	11,000		9,800	8,200																			
45		11,000	11,000	11,000		9,800	8,200																			
50		11,000	11,000	11,000		9,800	8,200																			
55		10,600	11,000	11,000		9,800	8,200					7,000	7,000													
60		10,200	10,600	10,600		9,800	8,200					6,800	6,800	7,000												
65		9,600	10,000	10,200		9,800	8,200					6,600	6,800	6,800												
70		9,200	9,600	9,800		9,600	8,200					6,400	6,600	6,600	6,600											
75		8,800	9,200	9,400		9,600	8,200					6,400	6,400	6,400	6,400	6,400						6,400				
80		8,400	8,800	9,000		9,200	8,200					6,200	6,200	6,400	6,400	6,400						6,400				
85		8,000	8,400	8,800		8,800	8,200					6,000	6,200	6,200	6,200	6,200						6,200				
90		7,600	8,200	8,390		8,450	8,200					6,000	6,000	6,200	6,200	6,200						6,200				
95		7,400	7,720	7,800		8,200	7,700					6,000	6,000	6,000	6,000	6,000						6,000				
100		7,200	7,400	7,600		7,400	6,820					5,800	6,000	6,000	6,000	6,000						6,000				
105		6,800	7,000	7,110		6,820	6,050					5,800	5,800	6,000	6,000	6,000						6,000				
110		6,600	6,800	6,400		6,320	5,350					5,800	5,800	5,800	5,800	5,800						5,800				
115		6,200	6,280	5,770		5,290	4,720					5,800	5,800	5,800	5,800	5,800						5,800				
120		5,830	5,700	5,190		4,710	4,150					5,800	5,800	5,800	5,590	5,190						5,190				
125		5,300	5,170	4,670		4,190	3,630						5,280	5,800	4,970	4,570						4,570				
130		4,820	4,690	4,190		3,710	3,150						4,700	4,400	4,400	3,990						3,990				
135			4,250	3,750		3,280	2,710							3,860	3,460	3,460						3,460				
140			3,850	3,340		2,870	2,310							3,370	2,970	2,970						2,970				
145				2,970		2,500	1,940								2,510	2,510						2,510				
150				2,620		2,150	1,590								2,080	2,080						2,080				
155				2,300		1,830	1,270																			
160						1,540																				
165						1,260																				
170						1,000																				

		89-142 ft					72 ft (16+56 ft)					20,500 lbs					100% 24'-0"					360				
		16' Insert + 56' Hydraulic Bi-Fold Swingaway Extension										16' Insert + 56' Hydraulic Bi-Fold Swingaway Extension														
		5 Deg Fixed Offset Angle					40 Deg Fixed Offset Angle					5 Deg Fixed Offset Angle					40 Deg Fixed Offset Angle									
Feet		89.3	102.4	115.5	128.6	141.8	89.3	102.4	115.5	128.6	141.8	89.3	102.4	115.5	128.6	141.8	89.3	102.4	115.5	128.6	141.8					
35		11,000																								
40		11,000	10,800	9,800																						
45		11,000	10,800	9,800		8,000																				
50		11,000	10,600	9,800		8,000	6,600																			
55		10,800	10,400	9,600		8,000	6,800																			
60		10,200	10,200	9,600		8,000	6,800					6,800														
65		9,600	9,800	9,400		8,000	6,600					6,600														
70		9,200	9,400	9,200		8,000	6,600					6,600	6,600	6,600												
75		8,800	9,000	9,000		8,000	6,600					6,400	6,400	6,400	6,400	6,200										
80		8,400	8,600	8,600		8,000	6,600					6,200	6,400	6,400	6,400	6,200										
85		8,000	8,400	8,400		8,000	6,600					6,200	6,200	6,200	6,200	6,200										
90		7,800	8,000	8,000		7,800	6,600					6,000	6,200	6,200	6,200	6,200										
95		7,400	7,600	7,490		7,490	6,600					6,000	6,000	6,000	6,200	6,000										
100		7,200	6,960	6,610		6,800	6,600					5,800	6,000	6,000	6,000	6,000										
105		6,800	6,170	6,200		6,400	5,980					5,800	5,800	6,000	6,000	6,000										
110		6,270	5,800	6,000		5,850	5,290					5,800	5,800	5,800	5,800	5,800										
115		5,830	5,400	5,700		5,210	4,640					5,800	5,800	5,800	5,630	5,800										
120		5,050	5,200	5,120		4,630	4,060					5,680	5,200	5,400	5,600	5,220										
125		4,800	5,000	4,590		4,100	3,540					5,030	5,000	5,200	5,020	4,600										
130		4,400	4,610	4,110		3,620	3,060					4,800	4,790	4,450	4,450	4,030										
135		4,200	4,170	3,660		3,180	2,620					4,600	4,260	3,920	3,500	3,500										
140		3,940	3,760	3,250		2,770	2,210						3,760	3,430	3,010	3,010										
145		3,560	3,380	2,870		2,390	1,830						3,300	2,970	2,550	2,550										
150		3,210	3,030	2,520		2,050	1,490							2,540	2,130	2,130										
155			2,710	2,200		1,720	1,160							2,140	1,730	1,730										
160			2,410	1,890		1,420									1,350	1,350										
165				1,610		1,140										1,000										
170						1,350																				
175						1,110																				
180																										

TMS900E

**GROVE**

THIS CHART IS ONLY A GUIDE AND SHOULD NOT BE USED TO OPERATE THE CRANE. The individual crane's load chart, operating instructions and other instructional plates must be read and understood prior to operating the crane.

## load charts

89-142 ft    88 ft (32+56 ft)    20,500 lbs    100% 24'-0"    360

Pounds

Feet	32' Insert + 56' Hydraulic Bi-Fold Swingaway Extension 5 Deg Fixed Offset Angle					32' Insert + 56' Hydraulic Bi-Fold Swingaway Extension 40 Deg Fixed Offset Angle				
	89.3	102.4	115.5	128.6	141.8	89.3	102.4	115.5	128.6	141.8
40	9,600	9,200								
45	9,200	9,000	7,800							
50	9,000	8,600	7,800	6,400	5,000					
55	8,600	8,400	7,800	6,400	5,000					
60	8,200	8,200	7,600	6,400	5,000					
65	7,800	7,800	7,400	6,400	5,000					
70	7,400	7,600	7,200	6,400	5,000	6,200	6,200			
75	7,200	7,200	7,000	6,400	5,000	6,000	6,000	6,000		
80	6,800	7,000	6,800	6,400	5,000	5,800	5,800	5,800	5,600	5,000
85	6,600	6,600	6,600	6,200	5,000	5,600	5,600	5,600	5,600	5,000
90	6,200	6,400	6,400	6,200	5,000	5,400	5,400	5,400	5,400	5,000
95	6,000	6,200	6,200	6,000	5,000	5,200	5,400	5,400	5,200	5,000
100	5,800	6,000	6,000	5,800	5,000	5,200	5,200	5,200	5,200	5,000
105	5,600	5,800	5,800	5,800	5,000	5,000	5,000	5,200	5,000	5,000
110	5,200	5,400	5,230	5,200	5,000	4,800	5,000	5,000	5,000	4,800
115	5,000	4,950	4,800	5,000	4,850	4,800	4,800	4,800	4,800	4,800
120	4,800	4,400	4,600	4,620	4,060	4,600	4,800	4,800	4,800	4,600
125	4,600	4,200	4,400	4,090	3,530	4,600	4,600	4,400	4,600	4,600
130	4,120	4,000	4,090	3,610	3,050	4,400	4,150	4,200	4,400	4,110
135	3,670	3,800	3,640	3,160	2,600	4,180	3,800	4,000	4,010	3,580
140	3,400	3,600	3,230	2,750	2,190	3,670	3,800	3,880	3,520	3,090
145	3,200	3,350	2,850	2,370	1,820		3,600	3,420	3,060	2,640
150	3,000	3,000	2,500	2,020	1,460		3,350	2,990	2,640	2,210
155	2,800	2,670	2,170	1,690	1,140			2,590	2,250	1,820
160	2,570	2,360	1,860	1,390				2,220	1,870	1,450
165			1,580	1,100					1,520	1,100
170			1,320						1,190	
175		1,570	1,060							
180										

21

89-142 ft    33 ft    20,500 lbs    100% 24'-0"    360

Pounds

Feet	33' Manual Bi-Fold Swingaway 0 Deg Fixed Offset Angle					33' Manual Bi-Fold Swingaway 40 Deg Fixed Offset Angle				
	89.3	102.4	115.5	128.6	141.8	89.3	102.4	115.5	128.6	141.8
20	22,000	22,000								
25	22,000	22,000	22,000							
30	22,000	22,000	22,000	17,400	13,600					
35	22,000	22,000	21,800	17,400	13,600					
40	22,000	22,000	21,400	17,400	13,600	14,000	14,200			
45	21,600	22,000	21,000	17,400	13,600	13,600	13,800	13,800		
50	19,800	21,000	20,400	17,400	13,600	13,200	13,400	13,600	13,600	11,400
55	18,400	19,400	19,600	17,200	13,600	12,800	13,000	13,200	13,200	11,400
60	17,400	17,050	16,800	16,600	13,600	12,400	12,600	12,800	13,000	11,400
65	15,850	14,700	14,450	14,600	13,600	12,000	12,200	12,400	12,800	11,400
70	13,700	13,200	13,200	13,600	13,000	11,600	11,800	12,000	12,600	11,400
75	12,400	12,400	12,400	12,000	11,250	11,400	11,600	11,600	12,200	11,400
80	11,700	11,600	11,150	10,650	10,000	11,200	10,800	10,800	11,000	11,250
85	10,500	10,450	9,940	9,430	8,810	10,200	10,200	10,200	10,450	9,960
90	9,440	9,380	8,850	8,350	7,740	9,800	9,800	9,630	9,260	8,790
95	8,480	8,430	7,900	7,400	6,790		8,930	8,570	8,200	7,730
100	7,640	7,580	7,050	6,560	5,960		7,980	7,620	7,260	6,790
105	6,890	6,830	6,300	5,810	5,210			6,780	6,420	5,960
110	6,230	6,150	5,630	5,140	4,540			6,010	5,670	5,200
115		5,550	5,020	4,530	3,940				4,980	4,520
120		5,010	4,470	3,980	3,390				4,350	3,900
125			3,970	3,490	2,900					3,330
130			3,520	3,040	2,440					2,800
135			3,120	2,620	2,030					
140				2,240	1,650					
145				1,890	1,300					
150				1,580						
155										
160										

TMS900E

THIS CHART IS ONLY A GUIDE AND SHOULD NOT BE USED TO OPERATE THE CRANE. The individual crane's load chart, operating instructions and other instructional plates must be read and understood prior to operating the crane.

**GROVE**



## load charts

89-142 ft    88 ft (32 + 56 ft)    20,500 lbs    100% 24'-0"    360

Pounds

Feet	32' insert + 56' Manual Bifold Swingaway 0 Deg Fixed Offset Angle					32' insert + 56' Manual Bifold Swingaway 40 Deg Fixed Offset Angle				
	89.3	102.4	115.5	128.6	141.8	89.3	102.4	115.5	128.6	141.8
35	10,000									
40	9,600	9,000	7,800							
45	9,200	9,000	7,800	6,400						
50	9,000	8,600	7,800	6,400	4,800					
55	8,800	8,400	7,800	6,400	4,800					
60	8,200	8,200	7,500	6,400	4,800					
65	7,800	7,800	7,400	6,400	4,800					
70	7,400	7,600	7,200	6,400	4,800	6,200	6,200			
75	7,200	7,200	7,000	6,400	4,800	6,000	6,000	6,000		
80	6,800	7,000	6,800	6,400	4,800	5,800	5,800	5,800	5,600	5,000
85	6,600	6,600	6,600	6,200	4,800	5,600	5,600	5,600	5,600	5,000
90	6,200	6,400	6,400	6,200	4,800	5,400	5,400	5,400	5,400	5,000
95	6,000	6,200	6,200	6,000	4,800	5,200	5,400	5,400	5,200	5,000
100	5,800	6,000	6,000	5,800	4,800	5,200	5,200	5,200	5,200	5,000
105	5,800	5,800	5,570	5,560	4,800	5,000	5,000	5,200	5,000	5,000
110	5,200	5,250	5,000	5,200	4,800	4,800	5,000	5,000	5,000	4,800
115	5,000	4,640	4,800	5,000	4,410	4,800	4,800	4,800	4,800	4,800
120	4,800	4,400	4,600	4,440	3,850	4,600	4,800	4,800	4,800	4,600
125	4,390	4,200	4,400	3,930	3,340	4,600	4,600	4,400	4,600	4,600
130	3,930	4,000	3,960	3,460	2,870	4,400	4,150	4,200	4,400	4,110
135	3,500	3,800	3,530	3,030	2,440	4,180	3,800	4,000	4,010	3,580
140	3,400	3,600	3,130	2,630	2,050	3,670	3,800	3,880	3,520	3,090
145	3,200	3,300	2,770	2,270	1,680		3,600	3,420	3,060	2,640
150	3,000	2,960	2,430	1,930	1,350		3,350	2,990	2,640	2,210
155		2,650	2,120	1,620	1,040			2,590	2,250	1,820
160		2,370	1,820	1,320				2,220	1,870	1,450
165		2,120	1,560	1,050					1,520	1,100
170			1,310						1,190	
175			1,080							
180										

23

TMS900E

THIS CHART IS ONLY A GUIDE AND SHOULD NOT BE USED TO OPERATE THE CRANE. The individual crane's load chart, operating instructions and other instructional plates must be read and understood prior to operating the crane.

GROVE

## load charts

24

37 - 142 ft Fixed lengths    12,900 lbs    100% 24'-0"    360

Pounds

Feet	36.8	49.9	63.0	76.1	89.3	102.4	115.5	128.6	141.8
10	155,000	136,000	129,000	123,000	81,000				
15	109,500	111,000	105,000	99,000	81,000	59,000			
20	79,450	81,850	82,100	80,800	81,000	57,000			
25	57,750	61,000	62,050	61,900	60,600	51,000	42,400	34,000	26,600
30		47,500	48,500	48,300	47,100	46,000	39,600	33,800	26,600
35			36,300	37,450	38,600	37,700	35,700	32,000	26,600
40				29,950	31,200	31,000	30,200	28,900	26,600
45					25,750	25,600	25,900	24,950	24,300
50						21,600	21,700	20,750	20,150
55							18,450	17,950	16,900
60								15,800	14,900
65									13,250
70									
75									
80									
85									
90									
95									
100									
105									
110									
115									
120									
125									
130									

89-142 ft    33 ft    12,900 lbs    100% 24'-0"    360

Pounds

Feet	33' Hydraulic Bi-Fold Swingaway 5 Deg Fixed Offset Angle					33' Hydraulic Bi-Fold Swingaway 40 Deg Fixed Offset Angle				
	89.3	102.4	115.5	128.6	141.8	89.3	102.4	115.5	128.6	141.8
20	22,000									
25	22,000	22,000								
30	22,000	22,000	22,000	17,800						
35	22,000	22,000	21,800	17,800	13,800					
40	22,000	22,000	21,400	17,800	13,800	14,000	14,200			
45	21,600	22,000	21,000	17,800	13,800	13,600	13,800	13,800		
50	19,800	20,500	20,200	17,800	13,800	13,200	13,400	13,600	13,600	11,400
55	18,100	17,150	16,850	17,050	13,800	12,800	13,000	13,200	13,200	11,400
60	15,450	15,200	15,200	15,400	13,800	12,400	12,600	12,800	13,000	11,400
65	14,000	14,000	13,800	13,300	12,650	12,000	12,200	12,400	12,800	11,400
70	12,600	12,550	12,000	11,450	10,950	11,600	11,800	11,800	11,900	11,400
75	11,100	11,100	10,550	10,050	9,470	11,000	11,200	11,400	11,150	10,700
80	9,840	9,810	9,290	8,790	8,180	10,400	10,500	10,100	9,760	9,290
85	8,710	8,680	8,160	7,670	7,070	9,180	9,280	8,910	8,530	8,060
90	7,730	7,700	7,190	6,700	6,110	8,090	8,200	7,830	7,460	6,990
95	6,870	6,830	6,330	5,840	5,260		7,240	6,870	6,510	6,040
100	6,110	6,070	5,560	5,090	4,500		6,380	6,030	5,670	5,200
105	5,430	5,390	4,890	4,410	3,830			5,270	4,910	4,450
110	4,830	4,780	4,280	3,810	3,230			4,580	4,230	3,770
115		4,230	3,730	3,260	2,680				3,620	3,160
120			3,230	2,770	2,190				3,050	2,600
125				2,780	2,320					2,080
130					1,910					1,610
135					1,530					
140					1,180					
145										

TMS900E

GROVE

THIS CHART IS ONLY A GUIDE AND SHOULD NOT BE USED TO OPERATE THE CRANE. The individual crane's load chart, operating instructions and other instructional plates must be read and understood prior to operating the crane.

## load charts

89-142 ft   56 ft   12,900 lbs   100% 24'-0"   360

Pounds

25

Feet	56' Hydraulic Bi-Fold Swingaway 5 Deg Fixed Offset Angle					56' Hydraulic Bi-Fold Swingaway 40 Deg Fixed Offset Angle				
	89.3	102.4	115.5	128.6	141.8	89.3	102.4	115.5	128.6	141.8
30	11,000	11,000	11,000							
35	11,000	11,000	11,000	9,800						
40	11,000	11,000	11,000	9,800	8,200					
45	11,000	11,000	11,000	9,800	8,200					
50	11,000	11,000	11,000	9,800	8,200					
55	10,600	11,000	11,000	9,800	8,200	7,000	7,000			
60	10,200	10,600	10,800	9,800	8,200	6,800	6,800	7,000		
65	9,600	10,000	10,200	9,800	8,200	6,600	6,800	6,800		
70	9,200	9,600	9,800	9,600	8,200	6,400	6,800	6,600	6,600	
75	8,800	9,200	9,400	9,600	8,200	6,400	6,400	6,400	6,400	6,400
80	8,400	8,800	8,800	9,000	8,200	6,200	6,200	6,400	6,400	6,400
85	8,000	8,200	8,400	8,460	7,880	6,000	6,200	6,200	6,200	6,200
90	7,600	7,800	7,970	7,460	6,880	6,000	6,000	6,200	6,200	6,200
95	7,200	7,600	7,080	6,580	6,000	6,000	6,000	6,000	6,000	6,000
100	6,940	6,810	6,300	5,810	5,230	5,800	6,000	6,000	6,000	6,000
105	6,240	6,110	5,600	5,110	4,540	5,800	5,800	5,800	6,000	5,300
110	5,610	5,480	4,970	4,490	3,920	5,800	5,800	5,800	5,580	5,180
115	5,040	4,910	4,410	3,920	3,350	5,800	5,550	5,230	4,910	4,500
120	4,530	4,400	3,890	3,410	2,850		4,920	4,610	4,290	3,890
125	4,060	3,930	3,420	2,950	2,380			4,040	3,730	3,320
130	3,630	3,500	3,000	2,520	1,960			3,510	3,210	2,800
135		3,110	2,610	2,130	1,570				2,720	2,320
140		2,750	2,240	1,770	1,210				2,270	1,880
145			1,910	1,440						1,460
150			1,600	1,140						1,070
155			1,320							
160										

89-142 ft   72 ft (16 + 56 ft)   12,900 lbs   100% 24'-0"   360

Pounds

Feet	16' Insert+56' Hydraulic Bi-Fold SwingawayExtension 5 Deg Fixed Offset Angle					16' Insert+56' Hydraulic Bi-Fold SwingawayExtension 40 Deg Fixed Offset Angle				
	89.3	102.4	115.5	128.6	141.8	89.3	102.4	115.5	128.6	141.8
35	11,000									
40	11,000	10,800	9,800							
45	11,000	10,800	9,800	8,000						
50	11,000	10,600	9,800	8,000	6,600					
55	10,600	10,400	9,600	8,000	6,600					
60	10,200	10,200	9,600	8,000	6,600	6,800				
65	9,600	9,800	9,400	8,000	6,600	6,600				
70	9,200	9,400	9,200	8,000	6,600	6,600	6,600	6,600		
75	8,800	9,000	9,000	8,000	6,600	6,400	6,400	6,400	6,400	6,200
80	8,400	8,600	8,600	8,000	6,600	6,200	6,400	6,400	6,400	6,200
85	8,000	8,040	7,680	7,680	6,600	6,200	6,200	6,200	6,200	6,200
90	7,800	7,030	7,200	7,200	6,600	6,000	6,200	6,200	6,200	6,200
95	6,960	6,600	6,800	6,530	5,960	6,000	6,000	6,000	6,200	6,000
100	6,170	6,400	6,250	5,750	5,170	5,800	6,000	6,000	6,000	6,000
105	5,800	6,000	5,550	5,050	4,470	5,800	5,800	5,800	6,000	5,970
110	5,400	5,430	4,910	4,420	3,840	5,720	5,800	5,800	5,640	5,220
115	5,030	4,850	4,340	3,850	3,280	5,200	5,400	5,310	4,960	4,540
120	4,510	4,330	3,820	3,330	2,760	5,000	5,040	4,690	4,340	3,920
125	4,030	3,860	3,350	2,860	2,300	4,490	4,470	4,120	3,780	3,360
130	3,600	3,420	2,920	2,430	1,870		3,950	3,600	3,260	2,840
135	3,200	3,030	2,520	2,040	1,480		3,450	3,120	2,780	2,360
140	2,840	2,660	2,150	1,670	1,110			2,660	2,330	1,910
145	2,500	2,320	1,820	1,340				2,240	1,910	1,500
150	2,200	2,010	1,500	1,030					1,530	1,110
155		1,720	1,220						1,160	
160			1,460							
165										

TMS900E

THIS CHART IS ONLY A GUIDE AND SHOULD NOT BE USED TO OPERATE THE CRANE. The individual crane's load chart, operating instructions and other instructional plates must be read and understood prior to operating the crane.

**GROVE**

## load charts

26

89-142 ft    88 ft (32 + 56 ft)    12,900 lbs    100% 24'-0"    360

Pounds

Feet	32' Insert + 56' Hydraulic Bi-Fold Swingaway Extension 5 Deg Fixed Offset Angle					32' Insert + 56' Hydraulic Bi-Fold Swingaway Extension 40 Deg Fixed Offset Angle				
	89.3	102.4	115.5	128.6	141.8	89.3	102.4	115.5	128.6	141.8
40	9,600	9,200								
45	9,200	9,000	7,800							
50	9,000	8,600	7,800	6,400	5,000					
55	8,600	8,400	7,800	6,400	5,000					
60	8,200	8,200	7,600	6,400	5,000					
65	7,800	7,800	7,400	6,400	5,000					
70	7,400	7,600	7,200	6,400	5,000					
75	7,200	7,200	7,000	6,400	5,000	6,200	6,200			
80	6,800	7,000	6,800	6,400	5,000	6,000	6,000	6,000	5,600	5,000
85	6,600	6,600	6,600	6,200	5,000	5,800	5,800	5,800	5,600	5,000
90	6,200	6,400	6,400	6,200	5,000	5,400	5,400	5,400	5,400	5,000
95	6,000	6,200	5,920	5,870	5,000	5,200	5,400	5,400	5,200	5,000
100	5,800	5,500	5,600	5,600	5,000	5,200	5,200	5,200	5,200	5,000
105	5,580	5,000	5,200	5,050	4,480	5,000	5,000	5,200	5,000	5,000
110	4,940	4,800	4,920	4,420	3,850	4,800	5,000	5,000	5,000	4,800
115	4,400	4,600	4,340	3,840	3,250	4,800	4,700	4,800	4,800	4,630
120	4,200	4,320	3,820	3,320	2,760	4,600	4,400	4,600	4,430	4,010
125	3,800	3,850	3,340	2,850	2,290	4,070	4,200	4,230	3,860	3,440
130	3,600	3,410	2,900	2,420	1,860	3,800	4,000	3,710	3,340	2,920
135	3,210	3,010	2,500	2,020	1,460	3,600	3,590	3,220	2,860	2,440
140	2,840	2,640	2,130	1,650	1,100	3,210	3,140	2,780	2,420	1,990
145	2,500	2,300	1,790	1,310			2,730	2,360	2,010	1,580
150	2,190	1,980	1,480	1,000			2,330	1,980	1,620	1,200
155	1,900	1,690	1,190					1,610	1,260	
160	1,630	1,420						1,270		
165		1,160								
170										

89-142 ft    33 ft    12,900 lbs    100% 24'-0"    360

Pounds

Feet	33' Manual Offset Bi-Fold Swingaway 0 Deg Fixed Offset Angle					33' Manual Offset Bi-Fold Swingaway 40 Deg Fixed Offset Angle				
	89.3	102.4	115.5	128.6	141.8	89.3	102.4	115.5	128.6	141.8
20	22,000	22,000								
25	22,000	22,000	22,000							
30	22,000	22,000	22,000	17,400	13,600					
35	22,000	22,000	21,800	17,400	13,600					
40	22,000	22,000	21,400	17,400	13,600	14,000	14,200			
45	21,600	22,000	21,000	17,400	13,600	13,600	13,800	13,800		
50	19,800	20,100	19,800	17,400	13,600	13,200	13,400	13,600	13,600	11,400
55	17,800	16,800	16,500	16,700	13,600	12,800	13,000	13,200	13,200	11,400
60	15,150	15,200	15,200	15,150	13,600	12,400	12,600	12,800	13,000	11,400
65	14,000	14,000	13,600	13,000	12,350	12,000	12,200	12,400	12,800	11,400
70	12,400	12,350	11,800	11,250	10,700	11,600	11,800	11,800	11,900	11,400
75	10,950	10,950	10,400	9,870	9,240	11,000	11,200	11,400	11,150	10,700
80	9,710	9,660	9,120	8,600	7,980	10,400	10,500	10,100	9,760	9,290
85	8,600	8,550	8,020	7,500	6,890	9,180	9,280	8,910	8,530	8,060
90	7,640	7,580	7,050	6,550	5,940	8,090	8,200	7,830	7,460	6,990
95	6,790	6,740	6,210	5,710	5,100		7,240	6,870	6,510	6,040
100	6,040	5,990	5,460	4,960	4,360		6,380	6,030	5,670	5,200
105	5,380	5,320	4,790	4,300	3,700			5,270	4,910	4,450
110	4,800	4,720	4,190	3,710	3,110			4,580	4,230	3,770
115		4,190	3,660	3,170	2,580				3,620	3,160
120		3,710	3,170	2,690	2,090				3,050	2,600
125			2,730	2,250	1,650					2,080
130			2,330	1,850	1,250					1,610
135			1,970	1,480						
140				1,140						

TMS900E

**GROVE**

THIS CHART IS ONLY A GUIDE AND SHOULD NOT BE USED TO OPERATE THE CRANE. The individual crane's load chart, operating instructions and other instructional plates must be read and understood prior to operating the crane.

## load charts

89-142 ft 56 ft 12,900 lbs 100% 24'-0" 360

27

Feet	56' Manual Bi-Fold Swingaway 0 Deg Fixed Offset Angle					56' Manual Bi-Fold Swingaway 40 Deg Fixed Offset Angle				
	89.3	102.4	115.5	128.6	141.8	89.3	102.4	115.5	128.6	141.8
25	11,000									
30	11,000	11,000	11,000							
35	11,000	11,000	11,000	9,800						
40	11,000	11,000	11,000	9,800	7,800					
45	11,000	11,000	11,000	9,800	7,800					
50	11,000	11,000	11,000	9,800	7,800					
55	10,600	11,000	11,000	9,800	7,800	7,000	7,000			
60	10,200	10,600	10,800	9,800	7,800	6,800	6,800	7,000		
65	9,800	10,000	10,200	9,800	7,800	6,600	6,800	6,800		
70	9,200	9,600	9,800	9,600	7,800	6,400	6,600	6,600	6,600	
75	8,800	9,200	9,400	9,600	7,800	6,400	6,400	6,400	6,400	6,400
80	8,400	8,600	8,800	8,800	7,800	6,200	6,200	6,400	6,400	6,400
85	8,000	8,200	8,400	8,150	7,530	6,000	6,200	6,200	6,200	6,200
90	7,600	7,800	7,710	7,180	6,560	6,000	6,000	6,200	6,200	6,200
95	7,200	7,390	6,850	6,320	5,710	6,000	6,000	6,000	6,000	6,000
100	6,770	6,620	6,060	5,560	4,960	5,800	6,000	6,000	6,000	6,000
105	6,090	5,940	5,400	4,890	4,290	5,800	5,800	5,900	6,000	5,930
110	5,480	5,330	4,790	4,280	3,680	5,800	5,800	5,900	5,900	5,180
115	4,930	4,780	4,240	3,740	3,140		5,550	5,230	4,910	4,500
120	4,440	4,280	3,740	3,240	2,650		4,920	4,610	4,290	3,890
125	3,990	3,830	3,290	2,790	2,200			4,040	3,730	3,320
130	3,580	3,410	2,880	2,380	1,790			3,510	3,210	2,800
135		3,040	2,500	2,000	1,420				2,720	2,320
140		2,690	2,150	1,660	1,070				2,270	1,880
145			1,830	1,340						1,460
150			1,540	1,040						1,070
155			1,270							

89-142 ft 72 ft (16 + 56) 12,900 lbs 100% 24'-0" 360

Feet	16' Insert +56' Manual Offset Bi-Fold Swingaway 0 Deg Fixed Offset Angle					16' Insert +56' Manual Offset Bi-Fold Swingaway 40 Deg Fixed Offset Angle				
	89.3	102.4	115.5	128.6	141.8	89.3	102.4	115.5	128.6	141.8
30	11,000									
35	11,000	11,000								
40	11,000	10,800	9,400	8,000						
45	11,000	10,800	9,400	8,000	6,400					
50	11,000	10,600	9,400	8,000	6,400					
55	10,600	10,400	9,400	8,000	6,400					
60	10,200	10,200	9,400	8,000	6,400	6,800				
65	9,800	9,800	9,400	8,000	6,400	6,600				
70	9,200	9,400	9,200	8,000	6,400	6,600	6,600	6,600		
75	8,800	9,000	9,000	8,000	6,400	6,400	6,400	6,400	6,400	6,200
80	8,400	8,600	8,450	8,000	6,400	6,200	6,400	6,400	6,400	6,200
85	8,000	7,710	7,600	7,320	6,400	6,200	6,200	6,200	6,200	6,200
90	7,590	7,000	7,200	7,000	6,400	6,000	6,200	6,200	6,200	6,200
95	6,720	6,600	6,790	6,260	5,650	6,000	6,000	6,000	6,200	6,000
100	6,000	6,400	6,020	5,490	4,890	5,800	6,000	6,000	6,000	6,000
105	5,800	5,870	5,330	4,810	4,210	5,800	5,800	5,800	6,000	5,970
110	5,400	5,250	4,710	4,190	3,600	5,720	5,800	5,800	5,640	5,220
115	4,990	4,690	4,160	3,640	3,050	5,200	5,400	5,310	4,960	4,540
120	4,380	4,190	3,650	3,140	2,550	5,000	5,040	4,890	4,340	3,920
125	3,930	3,730	3,190	2,680	2,100	4,490	4,470	4,120	3,780	3,360
130	3,510	3,310	2,770	2,270	1,680		3,950	3,600	3,260	2,840
135	3,120	2,920	2,390	1,890	1,300		3,450	3,120	2,780	2,360
140	2,780	2,570	2,040	1,540				2,660	2,330	1,910
145	2,460	2,250	1,710	1,210				2,240	1,910	1,500
150	2,170	1,950	1,410						1,530	1,110
155		1,670	1,130						1,160	
160		1,420								

TMS900E

THIS CHART IS ONLY A GUIDE AND SHOULD NOT BE USED TO OPERATE THE CRANE. The individual crane's load chart, operating instructions and other instructional plates must be read and understood prior to operating the crane.

**GROVE**

## load charts

28

Feet	32' Insert +56' Manual Offset Bi-Fold Swingaway					32' Insert +56' Manual Offset Bi-Fold Swingaway				
	0 Deg Fixed Offset Angle					40 Deg Fixed Offset Angle				
	89.3	102.4	115.5	128.6	141.8	89.3	102.4	115.5	128.6	141.8
35	10,000									
40	9,600	9,000	7,800							
45	9,200	9,000	7,800	6,400						
50	9,000	8,600	7,800	6,400	4,800					
55	8,600	8,400	7,800	6,400	4,800					
60	8,200	8,200	7,800	6,400	4,800					
65	7,800	7,800	7,400	6,400	4,800					
70	7,400	7,600	7,200	6,400	4,800	6,200	6,200			
75	7,200	7,200	7,000	6,400	4,800	6,000	6,000	6,000		
80	6,800	7,000	6,800	6,400	4,800	5,800	5,800	5,800	5,600	5,000
85	6,600	6,600	6,600	6,200	4,800	5,600	5,600	5,600	5,600	5,000
90	6,200	6,400	6,400	6,200	4,800	5,400	5,400	5,400	5,400	5,000
95	6,000	6,010	5,800	5,600	4,800	5,200	5,400	5,400	5,200	5,000
100	5,800	5,400	5,600	5,490	4,800	5,200	5,200	5,200	5,200	5,000
105	5,370	5,000	5,200	4,800	4,210	5,000	5,000	5,200	5,000	5,000
110	4,750	4,800	4,700	4,180	3,600	4,800	5,000	5,000	5,000	4,800
115	4,400	4,600	4,140	3,630	3,040	4,800	4,700	4,800	4,800	4,630
120	4,200	4,160	3,630	3,120	2,540	4,600	4,400	4,600	4,430	4,010
125	3,800	3,700	3,170	2,660	2,080	4,070	4,200	4,230	3,860	3,440
130	3,500	3,270	2,750	2,240	1,660	3,800	4,000	3,710	3,340	2,920
135	3,110	2,880	2,360	1,850	1,280	3,600	3,590	3,220	2,860	2,440
140	2,750	2,520	2,000	1,500		3,210	3,140	2,780	2,420	1,990
145	2,420	2,190	1,670	1,170			2,730	2,360	2,010	1,580
150	2,120	1,890	1,360				2,330	1,980	1,620	1,200
155	1,840	1,610	1,080					1,610	1,260	
160	1,580	1,350						1,270		
165		1,100								
170										

TMS900E

GROVE

THIS CHART IS ONLY A GUIDE AND SHOULD NOT BE USED TO OPERATE THE CRANE. The individual crane's load chart, operating instructions and other instructional plates must be read and understood prior to operating the crane.

## load charts

37 - 142 ft  
Fixed lengths

8,600 lbs

100%  
24'-0"

360

Pounds

Feet	36.8	49.9	63.0	76.1	89.3	102.4	115.5	128.6	141.8
10	154,000	136,000	129,000	123,000	81,000				
15	107,500	109,500	105,000	99,000	81,000	59,000			
20	75,750	78,150	78,400	78,000	78,850	57,000	42,400	32,800	
25	54,900	58,200	59,250	59,050	57,750	51,000	42,400	32,800	26,600
30		44,000	45,150	45,000	44,350	45,400	39,600	33,800	26,600
35		33,400	34,550	35,000	35,700	34,750	34,000	32,000	26,600
40			27,650	28,750	28,600	28,950	28,050	27,800	26,600
45			22,400	23,400	23,400	23,550	23,050	22,550	21,850
50			18,400	19,450	19,500	19,650	19,150	18,700	18,050
55			16,400	16,450	16,450	16,600	16,100	15,650	15,050
60			14,000	14,050	14,050	14,150	13,700	13,250	12,650
65			12,000	12,100	12,100	12,200	11,750	11,350	10,800
70				10,500	10,650	10,200	9,820	9,240	8,790
75				9,140	9,300	8,880	8,470	7,900	7,450
80					8,140	7,720	7,320	6,750	6,300
85					7,110	6,720	6,320	5,770	5,320
90					6,220	5,850	5,460	4,910	4,460
95						5,080	4,700	4,150	3,700
100						4,380	4,030	3,480	3,030
105							3,420	2,880	2,430
110							2,870	2,330	1,880
115							2,370	1,830	1,380
120								1,420	970
125								1,010	620

29

89-142 ft

33 ft

8,600 lbs

100%  
24'-0"

360

Pounds

Feet	33' Hydraulic Bi-Fold Swingaway 5 Deg Fixed Offset Angle					33' Hydraulic Bi-Fold Swingaway 40 Deg Fixed Offset Angle				
	89.3	102.4	115.5	128.6	141.8	89.3	102.4	115.5	128.6	141.8
20	22,000									
25	22,000	22,000								
30	22,000	22,000	22,000	17,800						
35	22,000	22,000	21,800	17,800	13,800					
40	22,000	22,000	21,400	17,800	13,800	14,000	14,200			
45	21,600	22,000	21,000	17,800	13,800	13,600	13,800	13,800		
50	19,400	18,400	18,150	17,800	13,800	13,200	13,400	13,600	13,600	11,400
55	16,250	16,200	16,400	16,200	13,800	12,800	13,000	13,200	13,200	11,400
60	14,950	14,900	14,350	13,800	13,250	12,400	12,600	12,800	13,000	11,400
65	12,900	12,850	12,300	11,800	11,250	12,000	12,200	12,200	12,350	11,400
70	11,200	11,250	10,750	10,200	9,610	11,600	11,600	11,750	11,350	11,000
75	9,880	9,850	9,330	8,820	8,210	10,600	10,650	10,300	9,920	9,450
80	8,670	8,640	8,120	7,620	7,010	9,270	9,350	8,980	8,590	8,120
85	7,620	7,590	7,080	6,580	5,980	8,100	8,190	7,820	7,440	6,970
90	6,710	6,680	6,170	5,680	5,090	7,070	7,180	6,810	6,440	5,970
95	5,910	5,880	5,370	4,890	4,300		6,280	5,920	5,550	5,080
100	5,200	5,170	4,660	4,180	3,600		5,480	5,120	4,760	4,300
105	4,580	4,540	4,030	3,560	2,980			4,410	4,060	3,590
110	4,020	3,970	3,470	3,000	2,420			3,770	3,420	2,960
115		3,460	2,960	2,490	1,910				2,850	2,380
120		3,000	2,500	2,030	1,460				2,320	1,860
125			2,080	1,610	1,040					1,350
130			1,700	1,230						
135			1,350							
140										

TMS900E

THIS CHART IS ONLY A GUIDE AND SHOULD NOT BE USED TO OPERATE THE CRANE. The individual crane's load chart, operating instructions and other instructional plates must be read and understood prior to operating the crane.

GROVE

## load charts

**30**

89-142 ft   56 ft   8,600 lbs   100% 24'-0"   360

Pounds

Feet	56' Hydraulic Bi-Fold Swingaway 5 Deg Fixed Offset Angle					56' Hydraulic Bi-Fold Swingaway 40 Deg Fixed Offset Angle				
	89.3	102.4	115.5	128.6	141.8	89.3	102.4	115.5	128.6	141.8
30	11,000	11,000	11,000							
35	11,000	11,000	11,000	9,800						
40	11,000	11,000	11,000	9,800	8,200					
45	11,000	11,000	11,000	9,800	8,200					
50	11,000	11,000	11,000	9,800	8,200					
55	10,600	11,000	11,000	9,800	8,200	7,000	7,000			
60	10,200	10,600	10,800	9,800	8,200	6,800	6,800	7,000		
65	9,600	10,000	10,200	9,800	8,200	6,600	6,800	6,800		
70	9,200	9,600	9,800	9,600	8,200	6,400	6,600	6,600	6,600	
75	8,800	9,100	9,200	9,000	8,200	6,400	6,400	6,400	6,400	6,400
80	8,400	8,800	8,800	8,440	7,950	6,200	6,200	6,400	6,400	6,400
85	7,900	8,200	7,980	7,370	6,790	6,000	6,200	6,200	6,200	6,200
90	7,600	7,460	6,950	6,440	5,860	6,000	6,000	6,200	6,200	6,200
95	6,770	6,640	6,120	5,630	5,050	6,000	6,000	6,000	6,000	6,000
100	6,040	5,910	5,390	4,900	4,330	5,800	5,800	6,000	6,000	5,850
105	5,380	5,250	4,740	4,260	3,680	5,800	5,800	5,800	5,470	5,070
110	4,800	4,670	4,160	3,680	3,100	5,370	5,420	5,100	4,770	4,370
115	4,270	4,140	3,630	3,150	2,580		4,780	4,460	4,140	3,730
120	3,790	3,660	3,160	2,680	2,110		4,190	3,870	3,560	3,150
125	3,360	3,230	2,720	2,250	1,680			3,340	3,020	2,620
130	2,960	2,830	2,320	1,850	1,290			2,830	2,530	2,130
135		2,460	1,960	1,490					2,080	1,680
140		2,130	1,620	1,150					1,650	1,260
145			1,310							
150			1,030							
155										

89-142 ft   33 ft   8,600 lbs   100% 24'-0"   360

Pounds

Feet	33' Manual Bi-Fold Swingaway 0 Deg Fixed Offset Angle					33' Manual Bi-Fold Swingaway 40 Deg Fixed Offset Angle				
	89.3	102.4	115.5	128.6	141.8	89.3	102.4	115.5	128.6	141.8
20	22,000	22,000								
25	22,000	22,000	22,000							
30	22,000	22,000	22,000	17,400	13,600					
35	22,000	22,000	21,800	17,400	13,600					
40	22,000	22,000	21,400	17,400	13,600					
45	21,600	22,000	21,000	17,400	13,600	14,000	14,200			
50	19,050	18,000	17,700	17,400	13,600	13,200	13,400	13,600	13,600	11,400
55	16,000	16,200	16,400	15,950	13,600	12,800	13,000	13,200	13,200	11,400
60	14,750	14,650	14,100	13,500	12,850	12,400	12,600	12,800	13,000	11,400
65	12,700	12,650	12,100	11,500	10,950	12,000	12,200	12,200	12,350	11,400
70	11,100	11,050	10,500	10,000	9,360	11,600	11,600	11,750	11,350	11,000
75	9,730	9,690	9,140	8,610	7,980	10,600	10,650	10,300	9,920	9,450
80	8,540	8,490	7,950	7,430	6,810	9,270	9,350	8,980	8,590	8,120
85	7,510	7,460	6,930	6,410	5,800	8,100	8,190	7,820	7,440	6,970
90	6,620	6,570	6,030	5,530	4,920	7,070	7,160	6,810	6,440	5,970
95	5,830	5,780	5,250	4,750	4,140		6,280	5,920	5,550	5,080
100	5,140	5,080	4,560	4,060	3,460	5,480	5,120	4,760	4,300	
105	4,530	4,460	3,940	3,450	2,850		4,410	4,060	3,590	
110	3,990	3,910	3,380	2,900	2,300		3,770	3,420	2,960	
115		3,420	2,890	2,400	1,800			2,850	2,380	
120		2,970	2,440	1,950	1,360			2,320	1,860	
125			2,030	1,540					1,380	
130			1,660	1,170						
135			1,330							
140										

TMS900E

**GROVE**

THIS CHART IS ONLY A GUIDE AND SHOULD NOT BE USED TO OPERATE THE CRANE. The individual crane's load chart, operating instructions and other instructional plates must be read and understood prior to operating the crane.

## load charts

89-142 ft   56 ft   8,600 lbs   100% 24'-0"   360

Pounds

Feet	56' Manual Bi-Fold Swingaway 0 Deg Fixed Offset Angle					56' Manual Bi-Fold Swingaway 40 Deg Fixed Offset Angle				
	89.3	102.4	115.5	128.6	141.8	89.3	102.4	115.5	128.6	141.8
25	11,000									
30	11,000	11,000	11,000	9,800						
35	11,000	11,000	11,000	9,800	7,800					
40	11,000	11,000	11,000	9,800	7,800					
45	11,000	11,000	11,000	9,800	7,800					
50	11,000	11,000	11,000	9,800	7,800					
55	10,600	11,000	11,000	9,800	7,800	7,000	7,000			
60	10,200	10,600	10,800	9,800	7,800	6,800	6,800	7,000		
65	9,600	10,000	10,200	9,800	7,800	6,600	6,800	6,800		
70	9,200	9,600	9,760	9,600	7,800	6,400	6,600	6,600	6,600	
75	8,800	8,800	9,200	8,800	7,800	6,400	6,400	6,400	6,400	6,400
80	8,400	8,600	8,650	8,100	7,470	6,200	6,200	6,400	6,400	6,400
85	7,800	8,150	7,600	7,060	6,440	6,000	6,200	6,200	6,200	6,200
90	7,390	7,240	6,690	6,160	5,540	6,000	6,000	6,200	6,200	6,200
95	6,580	6,430	5,890	5,370	4,760	6,000	6,000	6,000	6,000	6,000
100	5,870	5,720	5,180	4,660	4,060	5,800	5,800	6,000	6,000	5,850
105	5,240	5,090	4,550	4,030	3,430	5,800	5,800	5,800	5,470	5,070
110	4,670	4,520	3,980	3,470	2,870	5,370	5,420	5,100	4,770	4,370
115	4,160	4,010	3,470	2,970	2,370		4,780	4,460	4,140	3,730
120	3,700	3,540	3,010	2,510	1,910		4,190	3,870	3,560	3,150
125	3,280	3,120	2,590	2,090	1,500			3,340	3,020	2,620
130	2,910	2,740	2,210	1,710	1,120			2,830	2,530	2,130
135		2,390	1,850	1,360					2,080	1,680
140		2,070	1,530	1,040					1,650	1,260
145			1,240							
150										

31

TMS900E

THIS CHART IS ONLY A GUIDE AND SHOULD NOT BE USED TO OPERATE THE CRANE. The individual crane's load chart, operating instructions and other instructional plates must be read and understood prior to operating the crane.

GROVE

## load charts

**32**

37 - 142 ft Fixed lengths  
4,300 lbs  
100% 24'-0"  
360

Pounds

Feet	36.6	49.9	63.0	76.1	89.3	102.4	115.5	128.6	141.8
10	152,000	136,000	129,000	123,000	81,000				
15	106,000	108,000	105,000	99,000	81,000	59,000			
20	72,050	74,450	75,000	76,550	75,150	57,000	42,400	34,000	
25	52,100	55,400	56,400	58,250	54,950	51,000	42,400	34,000	26,600
30		40,350	41,500	41,400	42,750	41,800	39,600	33,800	26,600
35		30,400	31,800	33,000	32,800	32,000	32,300	30,450	26,600
40			24,850	25,950	25,750	26,100	25,600	25,050	24,350
45			19,350	21,000	21,050	21,200	20,750	20,200	19,550
50			16,350	17,350	17,400	17,550	17,100	16,600	15,950
55				14,550	14,600	14,750	14,300	13,800	13,200
60				12,350	12,400	12,500	12,050	11,600	11,100
65				10,500	10,600	10,750	10,350	9,900	9,340
70					9,150	9,290	8,970	8,450	7,870
75					7,880	8,040	7,620	7,210	6,640
80						6,970	6,550	6,150	5,590
85						6,020	5,630	5,230	4,880
90						5,200	4,830	4,440	3,890
95							4,120	3,740	3,190
100							3,480	3,120	2,580
105								2,570	2,030
110								2,060	1,540
115								1,600	1,100
120									

89-142 ft  
33 ft  
4,300 lbs  
100% 24'-0"  
360

Pounds

Feet	33' Hydraulic Bi-Fold Swingaway 5 Deg Fixed Offset Angle					33' Hydraulic Bi-Fold Swingaway 40 Deg Fixed Offset Angle				
	89.3	102.4	115.5	128.6	141.8	89.3	102.4	115.5	128.6	141.8
20	22,000									
25	22,000	22,000								
30	22,000	22,000	22,000	17,800						
35	22,000	22,000	21,800	17,800	13,800					
40	22,000	22,000	21,400	17,800	13,800	14,000	14,200			
45	21,100	20,100	19,800	17,800	13,800	13,800	13,800	13,800		
50	17,300	17,400	17,400	16,250	13,800	13,200	13,400	13,600	13,600	11,400
55	15,650	15,600	15,000	14,450	13,800	12,800	13,000	13,200	13,200	11,400
60	13,300	13,250	12,700	12,150	11,500	12,400	12,600	12,700	12,950	11,400
65	11,400	11,350	10,900	10,400	9,780	12,000	12,000	12,100	11,700	11,250
70	9,940	9,910	9,380	8,860	8,240	10,800	10,850	10,500	10,100	9,640
75	8,620	8,590	8,070	7,560	6,950	9,350	9,430	9,050	8,660	8,190
80	7,500	7,470	6,950	6,450	5,850	8,100	8,190	7,810	7,430	6,950
85	6,530	6,500	5,990	5,490	4,900	7,010	7,110	6,730	6,360	5,880
90	5,690	5,660	5,150	4,660	4,070	6,050	6,160	5,790	5,420	4,950
95	4,950	4,920	4,410	3,930	3,340		5,330	4,960	4,590	4,120
100	4,300	4,270	3,760	3,280	2,700		4,580	4,220	3,860	3,390
105	3,720	3,680	3,180	2,700	2,120			3,560	3,200	2,740
110	3,210	3,160	2,660	2,190	1,610			2,960	2,610	2,150
115		2,690	2,190	1,720	1,140				2,070	1,610
120		2,270	1,760	1,300					1,580	1,130
125			1,380							
130			1,020							
135										

TMS900E

**GROVE**

THIS CHART IS ONLY A GUIDE AND SHOULD NOT BE USED TO OPERATE THE CRANE. The individual crane's load chart, operating instructions and other instructional plates must be read and understood prior to operating the crane.

## load charts

89-142 ft 56 ft 4,300 lbs 100% 24'-0" 360

Pounds **33**

Feet	56' Hydraulic Bi-Fold Swingaway 5 Deg Fixed Offset Angle					56' Hydraulic Bi-Fold Swingaway 40 Deg Fixed Offset Angle				
	89.3	102.4	115.5	128.6	141.8	89.3	102.4	115.5	128.6	141.8
30	11,000	11,000	11,000							
35	11,000	11,000	11,000	9,800						
40	11,000	11,000	11,000	9,800	8,200					
45	11,000	11,000	11,000	9,800	8,200					
50	11,000	11,000	11,000	9,800	8,200					
55	10,600	11,000	11,000	9,800	8,200	7,000	7,000			
60	10,200	10,600	10,800	9,800	8,200	6,800	6,800	7,000		
65	9,600	10,000	10,200	9,800	8,200	6,600	6,800	6,800		
70	9,200	9,200	9,600	9,000	8,200	6,400	6,600	6,600	6,600	
75	8,600	8,800	8,940	8,420	7,820	6,400	6,400	6,400	6,400	6,400
80	8,200	8,310	7,790	7,270	6,680	6,200	6,200	6,400	6,400	6,400
85	7,450	7,320	6,800	6,290	5,700	6,000	6,200	6,200	6,200	6,200
90	6,580	6,450	5,930	5,430	4,840	6,000	6,000	6,200	6,200	6,200
95	5,810	5,680	5,170	4,670	4,090	6,000	6,000	6,000	6,000	5,770
100	5,130	5,000	4,490	4,000	3,420	5,800	5,800	5,600	5,350	4,950
105	4,530	4,400	3,890	3,400	2,830	5,240	5,280	4,950	4,620	4,220
110	3,990	3,860	3,350	2,870	2,290	4,560	4,610	4,290	3,960	3,560
115	3,500	3,370	2,860	2,380	1,810		4,010	3,690	3,370	2,960
120	3,050	2,930	2,420	1,940	1,380		3,450	3,140	2,820	2,420
125	2,650	2,520	2,020	1,540				2,630	2,320	1,920
130	2,290	2,160	1,660	1,180				2,160	1,860	1,460
135		1,820	1,310						1,430	1,030
140		1,510	1,000						1,030	
145										

89-142 ft 33 ft 4,300 lbs 100% 24'-0" 360

Pounds

Feet	33' Manual Bi-Fold Swingaway 0 Deg Fixed Offset Angle					33' Manual Bi-Fold Swingaway 40 Deg Fixed Offset Angle				
	89.3	102.4	115.5	128.6	141.8	89.3	102.4	115.5	128.6	141.8
20	22,000	22,000								
25	22,000	22,000	22,000							
30	22,000	22,000	22,000	17,400	13,600					
35	22,000	22,000	21,800	17,400	13,600					
40	22,000	22,000	21,400	17,400	13,600	14,000	14,200			
45	20,700	19,600	19,300	17,400	13,600	13,600	13,800	13,800		
50	17,200	17,400	17,400	16,000	13,600	13,200	13,400	13,600	13,600	11,400
55	15,350	15,300	14,700	14,100	13,400	12,800	13,000	13,200	13,200	11,400
60	13,050	13,000	12,450	11,850	11,300	12,400	12,600	12,700	12,950	11,400
65	11,300	11,250	10,700	10,150	9,490	12,000	12,000	12,100	11,700	11,250
70	9,760	9,720	9,170	8,630	7,990	10,800	10,850	10,500	10,100	9,640
75	8,470	8,430	7,880	7,350	6,720	9,350	9,430	9,050	8,660	8,190
80	7,370	7,320	6,780	6,260	5,640	8,100	8,190	7,810	7,430	6,950
85	6,420	6,370	5,840	5,330	4,710	7,010	7,110	6,730	6,360	5,880
90	5,600	5,550	5,020	4,510	3,900	6,050	6,160	5,790	5,420	4,950
95	4,880	4,820	4,290	3,790	3,190		5,330	4,960	4,590	4,120
100	4,240	4,180	3,650	3,160	2,550		4,580	4,220	3,860	3,390
105	3,680	3,610	3,080	2,590	1,990			3,560	3,200	2,740
110	3,180	3,100	2,570	2,080	1,480			2,960	2,610	2,150
115		2,640	2,110	1,630	1,030				2,070	1,610
120		2,240	1,700	1,220					1,580	1,130
125			1,330							
130										

TMS900E

THIS CHART IS ONLY A GUIDE AND SHOULD NOT BE USED TO OPERATE THE CRANE. The individual crane's load chart, operating instructions and other instructional plates must be read and understood prior to operating the crane.

**GROVE**

## load charts

34

89-142 ft   56 ft   4,300 lbs   100% 24'-0"   360

Pounds

Feet	56' Manual Bi-Fold Swingaway 0 Deg Fixed Offset Angle					56' Manual Bi-Fold Swingaway 40 Deg Fixed Offset Angle				
	89.3	102.4	115.5	128.6	141.8	89.3	102.4	115.5	128.6	141.8
25	11,000									
30	11,000	11,000	11,000	9,800						
35	11,000	11,000	11,000	9,800	7,800					
40	11,000	11,000	11,000	9,800	7,800					
45	11,000	11,000	11,000	9,800	7,800					
50	11,000	11,000	11,000	9,800	7,800					
55	10,600	11,000	11,000	9,800	7,800	7,000	7,000			
60	10,200	10,600	10,800	9,800	7,800	6,800	6,800	7,000		
65	9,600	10,000	9,920	9,800	7,800	6,600	6,800	6,800		
70	9,200	9,200	9,600	8,800	7,800	6,400	6,600	6,600	6,600	
75	8,600	8,800	8,800	8,040	7,410	6,400	6,400	6,400	6,400	6,400
80	8,190	8,040	7,480	6,930	6,300	6,200	6,200	6,400	6,400	6,400
85	7,220	7,070	6,510	5,970	5,350	6,000	6,200	6,200	6,200	6,200
90	6,370	6,220	5,670	5,140	4,530	6,000	6,000	6,200	6,200	6,200
95	5,630	5,480	4,930	4,410	3,800	6,000	6,000	6,000	6,000	6,000
100	4,970	4,820	4,280	3,760	3,150	5,800	5,800	5,800	5,350	4,950
105	4,380	4,230	3,690	3,180	2,580	5,240	5,280	4,950	4,620	4,220
110	3,860	3,710	3,170	2,660	2,060	4,560	4,610	4,290	3,960	3,560
115	3,390	3,240	2,700	2,190	1,600		4,010	3,690	3,370	2,960
120	2,960	2,810	2,270	1,770	1,180		3,450	3,140	2,820	2,420
125	2,580	2,420	1,880	1,390				2,630	2,320	1,920
130	2,230	2,070	1,530	1,030				2,160	1,860	1,460
135		1,750	1,210						1,430	1,030
140		1,450							1,030	
145										

37 - 142 ft Fixed lengths   0 lbs   100% 24'-0"   360

Pounds

Feet	36.8	49.9	63.0	76.1	89.3	102.4	115.5	128.6	141.8
10	149,500	136,000	129,000	123,000	81,000				
15	104,500	106,000	105,000	99,000	81,000	59,000			
20	68,350	70,750	73,050	72,850	71,450	57,000	42,400	34,000	
25	48,800	51,800	53,150	53,000	52,150	51,000	42,400	34,000	26,600
30		36,700	37,850	39,300	39,100	38,100	37,550	33,800	26,600
35			28,400	29,600	29,650	29,800	29,250	28,650	26,600
40				22,050	23,100	23,150	23,300	22,750	21,600
45					18,600	18,650	18,800	18,300	17,800
50						15,300	15,300	15,450	15,000
55							12,700	12,750	12,450
60								10,700	10,500
65									9,460
70									
75									
80									
85									
90									
95									
100									
105									
110									
115									





































TMS900E

GROVE

THIS CHART IS ONLY A GUIDE AND SHOULD NOT BE USED TO OPERATE THE CRANE. The individual crane's load chart, operating instructions and other instructional plates must be read and understood prior to operating the crane.

## Notes

### Symbols glossary

- |  |   |
|--|---|
|  Axle load            |  Lattice extension |
|  Boom elevation       |  Lights            |
|  Boom telescoping     |  Luffing jib       |
|  Brakes               |  Main boom         |
|  Cab                  |  Off road          |
|  Counterweight        |  Oil               |
|  Crane functions      |  Outriggers        |
|  Crane travel         |  Outrigger control |
|  Electrical System    |  Radius            |
|  Engine              |  Rotation         |
|  Fixed swing        |  Speed           |
|  Frame              |  Steering        |
|  Fuel tank capacity |  Suspension      |
|  Gear               |  Swing           |
|  Gradeability       |  Tele-swing      |
|  Heavy duty jib     |  Tires           |
|  Main hoist         |  Transmission    |
|  Auxiliary hoist    |  Travel speed    |
|  Hook height        |   |

35

TMS900E

GROVE

## GROVE®

**Manitowoc Crane Group - Americas**  
Tel: [Int + 001] 920 684 6621  
Fax: [Int + 001] 920 683 6277

**Manitowoc Crane Group - EMEA**  
Europe Middle East & Africa  
Tel: [Int + 33] (0) 191 565 6281  
Fax: [Int + 33] (0) 4 72 18 20 20

**Manitowoc Crane Group - UK**  
Europe Middle East & Africa  
Tel: [Int + 44] (0) 191 565 6281  
Fax: [Int + 44] (0) 191 564 0442

**Manitowoc Crane Group - Germany**  
(Sales, Parts & Service)  
Tel: [Int + 49] (0) 2173 8909 0  
Fax: [Int + 49] (0) 2173 8909-30

**Manitowoc Crane Group - France**  
France & Africa (Sales, Parts & Service)  
Tel: [Int + 33] (0) 1 303 13150  
Fax: [Int + 33] (0) 1 303 86085

**Manitowoc Crane Group - Netherlands**  
(Sales, Parts & Service)  
Tel: [Int + 31] (0) 76 578 39 99  
Fax: [Int + 31] (0) 76 578 39 78

**Manitowoc Crane Group - Italy**  
Italy & Southern Europe (Sales, Parts & Service)  
Tel: [Int + 39] (0) 331 49 33 11  
Fax: [Int + 39] (0) 331 49 33 30

**Manitowoc Crane Group - Portugal**  
Portugal & Spain (Sales, Parts & Service)  
Tel: [Int + 351] (0) 22 968 08 89  
Fax: [Int + 351] (0) 22 968 08 97

**Manitowoc Crane Group - Singapore**  
Asia/Pacific excl China (Sales, Parts & Service)  
Tel: [Int + 65] 6861 1733  
Fax: [Int + 65] 6862 4040 / 4142

**Manitowoc Crane Group - Shanghai**  
China (Sales, Parts & Service)  
Tel: [Int + 86] (0) 21 64955555  
Fax: [Int + 86] (0) 2164852038

**Manitowoc Crane Group - Beijing**  
China (Sales, Parts & Service)  
Tel: [Int + 86] (0) 10 646 71690  
Fax: [Int + 86] (0) 10 646 71691

**Manitowoc Crane Group - Middle East**  
Sales  
Tel: [Int + 971] (0) 4 348 4478  
Fax: [Int + 971] (0) 4 348 4478  
(Parts & Service)  
Tel: [Int + 973] (0) 9 660 899  
Fax: [Int + 973] (0) 2 707 740

**Distributed By:**

**Manitowoc**  
Crane CARE



www.manitowoccrane.com



Constant improvement and engineering progress make it necessary that we reserve the right to make specification, equipment, and price changes without notice. Illustrations shown may include optional equipment and accessories, and may not include all standard equipment.