

Grove Manitowoc National Crane Potain



## Grove GMK6350

### Product Guide



#### Features

- 15,5 m - 60 m (51 ft - 197 ft) five-section full power MEGAFORM™ boom
- 11 m - 19 m (36 ft - 62 ft) telescoping offsettable swingaway extension
- 21 m - 61 m (69 ft - 200 ft) luffing jib
- MEGALIFT™ main boom attachment
- 100 t (220,400 lb) counterweight with hydraulic removal system
- Independent hydro-pneumatic MEGATRAK™ suspension



## Features

### MEGATRAK™

The MEGATRAK™ suspension system is the best off road driveline available on the market today. The system's versatility and performance allows the GMK6350 to operate as a true all-terrain crane. The MEGATRAK™ independent suspension and all-wheel steer system allows wheels to remain on the ground at all times so stresses and weight are not continually transferred between axles. MEGATRAK™ provides true ground clearance where others just raise the chassis.

Other benefits of the MEGATRAK™ system are:

- A reliable suspension system
- Excellent job site maneuverability with all-wheel steering
- Commonality among almost all models
- A driveline that remains aligned at all times
- A steering linkage system that is protected against damage
- Constant tire contact for equal tire wear
- Reduced maintenance



### TWIN-LOCK™

Boom pinning mechanism automatically pins the sections in position using two horizontal pins.



### EKS 5 Light

Monitoring the lifting condition of the crane at all times EKS works together with, but independently of the ECOS as a complete command and control system or separately as a load moment indicator.

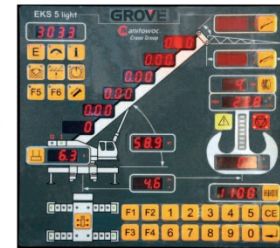

### ECOS

Electronic Crane Operating System - ECOS enables control of the entire crane's principle operations. Simple programming eases lift planning and a supply of essential information allows full concentration on the lift itself.



## Contents

Specifications	4
Dimensions	7
Trailing boom proposal	8
Counterweight	9
Load chart overview	10
Working range (main boom and swingaway)	11
Load charts (main boom)	12
Load charts (mainboom and swingaway)	13
Working range (with MEGALIFT™)	14
Load charts (with MEGALIFT™)	15
Working range (lattice extension)	16
Load charts (lattice extension)	17
Working range (luffing jib)	18
Load charts (luffing jib)	19
Symbols glossary	24

## Specifications

### Superstructure



#### Boom

15,5 m - 60 m (51 ft - 197 ft) five-section, full power MEGAFORM™ boom with patented TWIN-LOCK™ boom pinning system.

Maximum tip height: 63 m (207 ft).



#### Boom elevation

Single lift cylinder with safety valve provides boom angle from -1.5° to +82°.



#### \*Telescopic swingaway extension

11 m - 19 m (36 ft - 62 ft) telescoping offsettable swingaway extension. Offsettable at 5° and 30°.



#### Lattice extension

Luffing Jib is a lattice design with lengths of 21 m - 61 m (69 ft - 200 ft) in sections of 8 m (26 ft). The luffing jib converts to a fixed offset lattice jib using an offset angle adapter and provides lengths of 19 m - 59 m (62 ft - 194 ft) offsettable at 3° and 25°.



#### \*MEGALIFT™ attachment main boom

Consists of a mast, pendant lines, and hydraulic tensioning winch to support the main boom during lifting operations. Load charts available for main boom only as optional equipment.



#### Load moment and anti-two block system

Load moment and anti-two block system with audio/visual warning and control lever lockout provides electronic display of boom angle, length, radius, tip height, relative load moment, maximum permissible load, load indication and warning of impending two-block condition.



#### Cab

All aluminum construction cab is tiltable (approximately 20°) and includes safety glass and adjustable operator's seat with hydraulic suspension. Other features include engine dependent hot water heater, armrest integrated crane controls, and ergonomically arranged instrumentation.



#### Swing

Three (3) axial piston fixed displacement motors provide swing speed of 0 - 1.6 rpm thru planetary gear box. Also provided is a spring applied, hydraulically released automatic swing brake with foot operated release for free swing.



#### Counterweight

100 t (220,400 lb) consisting of various sections with hydraulic installation/removal system (see counterweight configuration on page 9).



#### Engine

Mercedes-Benz OM906LA, diesel, six (6) cylinders, water cooled, turbocharged, 205 kW (275 hp) at 1800 rpm.

Max. torque: 1100 Nm (811 ft/lb) at 1300 rpm.  
Engine emission: EUROMOT/EPA/CARB.



#### Fuel tank capacity

330 L (87 gal).



#### Hydraulic system

Four (4) separate circuits, three (3) axial piston variable displacement pumps with electronic power limiting control and 1 axial piston variable displacement pump for slewing. Standard thermostatically controlled oil cooler keeps oil at optimum operating temperature. Tank capacity: 1220 L (322 gal)



#### Crane control system

Full electronic control of all crane movements is accomplished using electrical control levers with automatic reset to zero. Controls are integrated with the LMI and engine management system by CAN-BUS.



#### Electrical system

24 V system with three-phase alternator 28 V/80 A, 2 batteries 12 V/170 Ah.

## Specifications

### Superstructure continued

#### Hoist

Main and auxiliary hoist are powered by axial piston variable displacement motor with planetary gear and brake. "Thumb-thumper" hoist drum rotation indicator alerts operator of hoist movement.

	Main	Auxiliary
<b>Line length:</b>	300m (984 ft)	420 m (1378 ft)
<b>Rope diameter:</b>	24 mm	24 mm
<b>Line speed:</b>	140 m/min (460 ft/min)	130 m/min (426 ft/min)
<b>Line pull:</b>	110 kN (24,700 lb)	110 kN (24,700 lb)

#### \*Optional hookblocks

Lifting capacity	No. of sheaves	Weight	Parts of line	Possible load with the crane*
200 t (220 USt)	9	3000 kg (6614 lb)	2-18/■19	193 t/200t■ (213 USt/220 USt)
160 t (176 USt)	7	2975 kg (6559 lb)	2-15	160 t (176 USt)
125 t (138 USt)	5	1650 kg (3638 lb)	2-11	120 t (132 USt)
80 t (88 USt)	3	1125 kg (2480 lb)	2-7	77 t (85 USt)
32 t (35 USt)	1	620 kg (1367 lb)	1-3	32 t (35 USt)
12 t (13 USt)	H/B	300 kg (661 lb)	1	11 t (12 USt)

■ Requires additional boom nose sheave.  
\*Varies depending on national regulations.

#### \*Optional equipment

- ▶ Engine-independent diesel heater, with engine pre-heater
- ▶ Second spotlight
- ▶ Stereo/CD player
- ▶ Air Conditioning
- ▶ Stainless steel exhaust system
- ▶ MEGALIFT™ attachment
- ▶ Engine independent propane cab heater
- ▶ Auxiliary boom nose
- ▶ Boom mounted work lights
- ▶ Aircraft warning light
- ▶ 24 hour timer for diesel heater

### Carrier

#### Chassis

Box-type, torsion resistant frame is fabricated from high-strength steel.

#### Outrigger system

Hydraulic two-stage outrigger beams are extended by a single hydraulic cylinder and two cables. Outriggers can adjust to two positions:

- Fully extended (100%) - 8,5 m (27 ft 11 in)
- Partially extended (50%) - 6 m (19 ft 8 in)

Four (4) 750 mm x 810 mm (29.5 in x 32 in), self stowing, steel outrigger pads provide rigid lifting base. Outrigger controls are located on both sides of the carrier. An electronic level indicator is located next to each outrigger control box. Outrigger monitoring system comes standard.

#### Engine

Mercedes-Benz OM502LA, diesel, eight (8) cylinders, water-cooled, turbocharged, 420 kW (563 hp) at 1800 rpm.  
Max. torque: 2700 Nm (1991 ft/lb) at 1080 rpm.  
Engine emission: EPA/CARB.

#### Fuel tank capacity

500 L (132 gal).

#### Transmission

Allison automatic CLT 755, 5 forward and 1 reverse speed. Transfer case with two (2) speeds and inter-axle differential lock.

#### Drive/steer

12 x 6 x 12.

#### Axles

Six (6) axles. 1, 2, 4 and 5 are drive/steer. Axles 3 and 6 are steer only.

## Specifications

### Carrier continued



#### Suspension

Grove GMK6350 features the Grove exclusive MEGATRAK™ suspension. This revolutionary design features an independent hydropneumatic system with hydraulic lockout acting on all wheels. The suspension can be raised 170 mm (6 ft 1/2 in) or lowered 130 mm (5 in) both longitudinally and transversely and features an automatic leveling system for on-highway travel.



#### Tires

12 tires, 16.00 R25 (vehicle width 9 ft 10 in)



#### Steering

Dual circuit steering system is hydraulic power assisted with a transfer case mounted, ground driven, emergency steering pump. Axles 1, 2, 3, 5 and 6 steer on highway. Separate steering of the 4th, 5th and 6th axle for all wheel steer and crab-steer is controlled by an electric rocker switch.



#### Brakes

A dual circuit air system operates on all wheels with a spring-applied, air released parking brake acting on axles 2, 4, 5 and 6. An air dryer is fitted to remove moisture from the air system. Engine compression brake is standard.



#### Cab

Two-man, aluminum construction driver's cab includes the following features: safety glass; driver and passenger seats with hydraulic suspension, engine-dependent hot water heater, complete instrumentation and driving controls.



#### Electrical system

24 V system with three-phase alternator 28 V/80 A, 2 batteries 12 V/170 Ah.



#### Maximum speed

77km/h (48 mph) with 16.00/20.5 tires.



#### Gradeability (theoretical)

46% with 20.5 R25 tires.

#### Miscellaneous standard equipment

Boom removal kit; trailing boom kit (less dolly); additional hydraulic oil cooler; removable rear outrigger box; flashing amber warning light on carrier cab; working light; tool kit; fire extinguisher; radio cassette in carrier cab.

#### \*Optional equipment

- ▶ 12 x 8 x 12
- ▶ Electric driveline retarder
- ▶ 20.5 tires
- ▶ Outrigger pressure measurement devices
- ▶ Engine-independent hot water heater, with engine pre-heater
- ▶ Stainless steel exhaust system
- ▶ Trailing boom "boost" weight transfer kit
- ▶ Air conditioning
- ▶ Spare tire and wheel
- ▶ Worklights for outriggers
- ▶ Engine independent propane cab heater
- ▶ Rear mounted stowage box

## Dimensions

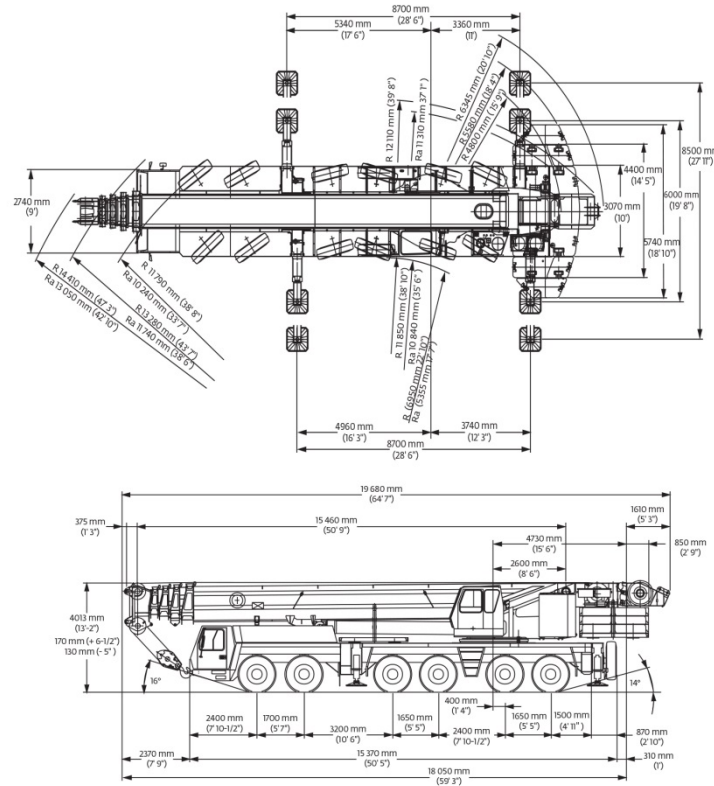

Basic weights-	Axles 1 and 2		Axles 3-6		Total	
Mercedes power, 12x6, 20.5 R25 tires, 2nd hydraulic oil cooler, brackets for swingaway	23 034 kg	50,781 lb	48 974 kg	107,969 lb	72 008 kg	158,750 lb
<b>Additions:</b>						
12x8x12 in lieu	438 kg	965 lb	-48 kg	-105 lb	390 kg	860 lb
Outrigger pads	-	-	350 kg	772 lb	350 kg	772 lb
Removable rear outrigger box option	-556 kg	-1225 lb	1556 kg	3430 lb	1000 kg	2205 lb
Auxiliary hoist	-2434 kg	-5365 lb	5194 kg	11,450 lb	2760 kg	6085 lb
Swingaway	3112 kg	6860 lb	-692 kg	-1525 lb	2420 kg	5335 lb
Spare wheel 20.5 with stowage	-268 kg	-590 lb	635 kg	1400 lb	367 kg	810 lb
Spare wheel 16.00 with stowage	-236 kg	-520 lb	562 kg	1240 lb	327 kg	720 lb
Spare wheel 14.00 with stowage	-193 kg	-425 lb	458 kg	1010 lb	265 kg	585 lb
Fixed MEGALIFT™ brackets without winch	296 kg	653 lb	-56 kg	-123 lb	240 kg	530 lb
Fixed bracket for MEGALIFT™ winch	54 kg	119 lb	96 kg	212 lb	150 kg	331 lb
Bolted parts for MEGALIFT™	54 kg	119 lb	96 kg	212 lb	150 kg	331 lb
MEGALIFT™ winch	2638 kg	6257 lb	2602 kg	5736 lb	5440 kg	11,993 lb
<b>Removal:</b>						
Front outrigger beams and jacks	-1533 kg	-3380 lb	-898 kg	-1980 lb	-2431 kg	-5360 lb
Rear outrigger beams and jacks	1692 kg	3730 lb	-4377 kg	-9650 lb	-2685 kg	-5920 lb
Outrigger box (must add weight above for option)	3062 kg	6750 lb	-7961 kg	-17,550 lb	-4899 kg	-10,800 lb
Boom assembly (minus lift cylinder)	-15 762 kg	-34,750 lb	-10 512 kg	-23,175 lb	-26 274 kg	-57,925 lb
Telescopic sections 1-4	-12 655 kg	-27,900 lb	-7194 kg	-15,860 lb	-19 849 kg	-43,760 lb
Lift cylinder	-1021 kg	-2250 lb	-1542 kg	-3400 lb	-2563 kg	-5650 lb
16.00 R25 tires in lieu	-168 kg	-370 lb	-336 kg	-740 lb	-503 kg	-1110 lb
14.00 R25 tires in lieu	-408 kg	-900 lb	-816 kg	-1800 lb	-1225 kg	-2700 lb

Grove GMK6350

7

## Trailing boom proposal

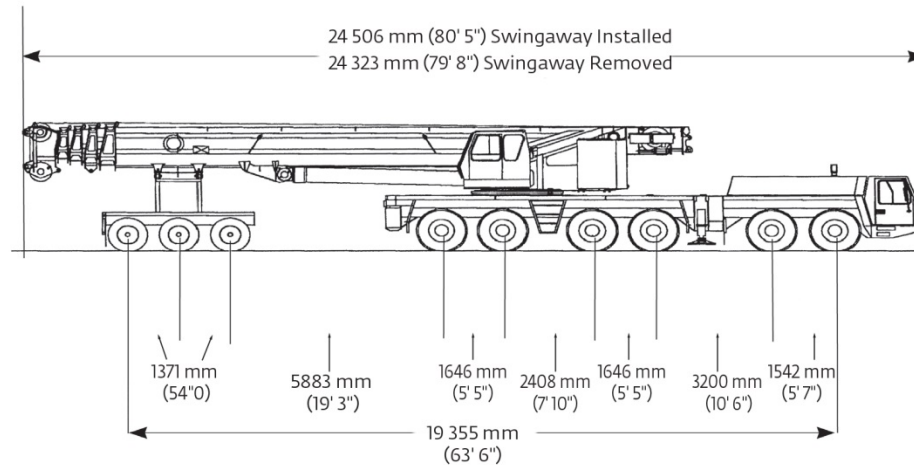

DOLLY	REAR 4 AXLES	FRONT 2 AXLES
20 646 kg (55,316 lb)	34 077 kg (91,299 lb)	12 984 kg (34,787 lb)
G.V.W.: 67 708 kg (181,402 lb)		

**UNIT EQUIPPED AS FOLLOWS:**

Mercedes engines carrier and superstructure, outrigger pads in place, frame equipped for removable outrigger box, rear box in place, main & auxiliary hoist with rope, swingaway on boom, 3-axle boom dolly (2837 kg [7600 lb]), 16.00 tires, counterweight removed. 12 x 6 x 12 drive.

**Weight effects:**

Component	Dolly	Rear Axles	Front Axles	Gross
Remove rear outrigger box	0	-6553 kg (-17,555 lb)	+2521 kg (+6753 lb)	-4032 kg (-10,802 lb)
Remove front outrigger beams	0	-739 kg (-1980 lb)	-1260 kg (-3377 lb)	-1999 kg (-5357 lb)
Remove rear outrigger beams	0	-3603 kg (-9652 lb)	+1393 kg (+3732 lb)	-2209 kg (-5919 lb)
Remove auxiliary hoist with rope	0	-796 kg (-2134 lb)	-1475 kg (-3951 lb)	-2271 kg (-6085 lb)
Remove swingaway	-2361 kg (-5205 lb)	+37 kg (+99 lb)	+13 kg (+35 lb)	-1893 kg (-5071 lb)
Add 12 x 8 x 12 Drive	0	-40 kg (-106 lb)	+361 kg (+966 lb)	+320 kg (+860 lb)
Fixed MEGALIFT brackets w/o winch	248 kg (547 lb)	-5 kg (-13 lb)	-2 kg (-4 lb)	197 kg (529 lb)
Fixed bracket for MEGALIFT winch	77 kg (170 lb)	44 kg (119 lb)	16 kg (42 lb)	124 kg (331 lb)
Bolted parts for MEGALIFT	77 kg (170 lb)	44 kg (119 lb)	16 kg (42 lb)	124 kg (331 lb)

## Counterweight

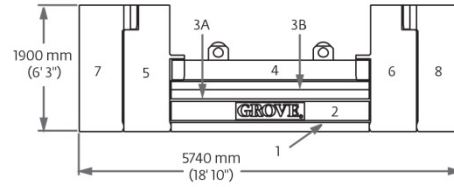



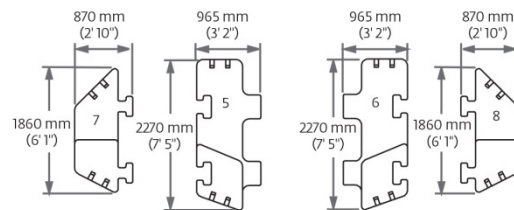
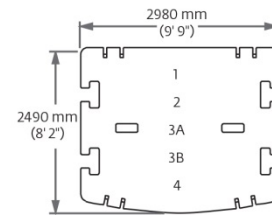
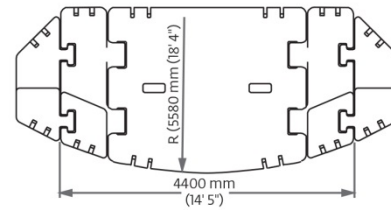

- 1. 8 t (17,600 lb)
- 2. 14 t (30,900 lb)
- 3A. 7 t (15,450 lb)
- 3B. 7 t (15,450 lb)
- 4. 14 t (30,900 lb)
- 5. 15 t (33,000 lb)
- 6. 15 t (33,000 lb)
- 7. 10 t (22,050 lb)
- 8. 10 t (22,050 lb)





	①	②	③A	③B	④	⑤	⑥	⑦	⑧
17,600 lb	X								
48,500 lb	X	X							
79,300 lb	X	X	X	X					
110,200 lb	X	X	X	X	X				
176,300 lb	X	X	X	X	X	X	X		
220,400 lb	X	X	X	X	X	X	X	X	X

## Load chart overview



 15,5 m - 60,0 m (51 ft - 197 ft)
  360°



 Feet
  Thousand pounds



 8,7 m - 8,5 m (28.5 ft x 27.9 ft)
  8,7 m - 6,0 m (28.5 ft x 19.7 ft)

	220.4	176.3	110.2	79.3	48.5	17.6	0	220.4	176.3	110.2	79.3	48.5	17.6	0
51	.	.	.	.	.	.	.	.	.	.	.	.	.	.
69	.	.	.	.	.	.	.	.	.	.	.	.	.	.
87	.	.	.	.	.	.	.	.	.	.	.	.	.	.
105	.	.	.	.	.	.	.	.	.	.	.	.	.	.
124	.	.	.	.	.	.	.	.	.	.	.	.	.	.
142	.	.	.	.	.	.	.	.	.	.	.	.	.	.
160	.	.	.	.	.	.	.	.	.	.	.	.	.	.
178	.	.	.	.	.	.	.	.	.	.	.	.	.	.
197	.	.	.	.	.	.	.	.	.	.	.	.	.	.



\*0° over rear



 5°, 25° 11,0 m/18,0 m (36 ft/59 ft)
  360°

 Feet
  Thousand pounds

 8,7 m - 8,5 m (28.5 ft x 27.9 ft)
  8,7 m - 6,0 m (28.5 ft x 19.7 ft)



	220.4	176.3	110.2	79.3	48.5	17.6		110.2	79.3	48.5
51	.	.	.	.	.	.	.	.	.	.
69	.	.	.	.	.	.	.	.	.	.
87	.	.	.	.	.	.	.	.	.	.
105	.	.	.	.	.	.	.	.	.	.
124	.	.	.	.	.	.	.	.	.	.
142	.	.	.	.	.	.	.	.	.	.
160	.	.	.	.	.	.	.	.	.	.
178	.	.	.	.	.	.	.	.	.	.
197	.	.	.	.	.	.	.	.	.	.

 5°, 25° 19,0 m/18,0 m (62 ft/167 ft)
  360°
  8,7 m - 8,5 m (28.5 ft x 27.9 ft)

 Feet
  Feet
  Thousand pounds

	220.4	176.3	110.2	79.3	48.5														
51	.	.	.	.	.	.	.	.	.	.	.	.	.	.	.	.	.	.	.
69	.	.	.	.	.	.	.	.	.	.	.	.	.	.	.	.	.	.	.
87	.	.	.	.	.	.	.	.	.	.	.	.	.	.	.	.	.	.	.
105	.	.	.	.	.	.	.	.	.	.	.	.	.	.	.	.	.	.	.
124	.	.	.	.	.	.	.	.	.	.	.	.	.	.	.	.	.	.	.
142	.	.	.	.	.	.	.	.	.	.	.	.	.	.	.	.	.	.	.
160	.	.	.	.	.	.	.	.	.	.	.	.	.	.	.	.	.	.	.
178	.	.	.	.	.	.	.	.	.	.	.	.	.	.	.	.	.	.	.
197	.	.	.	.	.	.	.	.	.	.	.	.	.	.	.	.	.	.	.

(1) 3° only

 15,5 m - 60,0 m (51 ft - 197 ft)
  5°, 25° 11,0 m/18,0 m (36 ft/59 ft)
  360°

 Thousand pounds

	220.4	176.3	110.2	79.3															
51	.	.	.	.	.	.	.	.	.	.	.	.	.	.	.	.	.	.	.
69	.	.	.	.	.	.	.	.	.	.	.	.	.	.	.	.	.	.	.
87	.	.	.	.	.	.	.	.	.	.	.	.	.	.	.	.	.	.	.
105	.	.	.	.	.	.	.	.	.	.	.	.	.	.	.	.	.	.	.
124	.	.	.	.	.	.	.	.	.	.	.	.	.	.	.	.	.	.	.
142	.	.	.	.	.	.	.	.	.	.	.	.	.	.	.	.	.	.	.
160	.	.	.	.	.	.	.	.	.	.	.	.	.	.	.	.	.	.	.
178	.	.	.	.	.	.	.	.	.	.	.	.	.	.	.	.	.	.	.

† Only with 82° boom angle

## Working range Main boom and swingaway

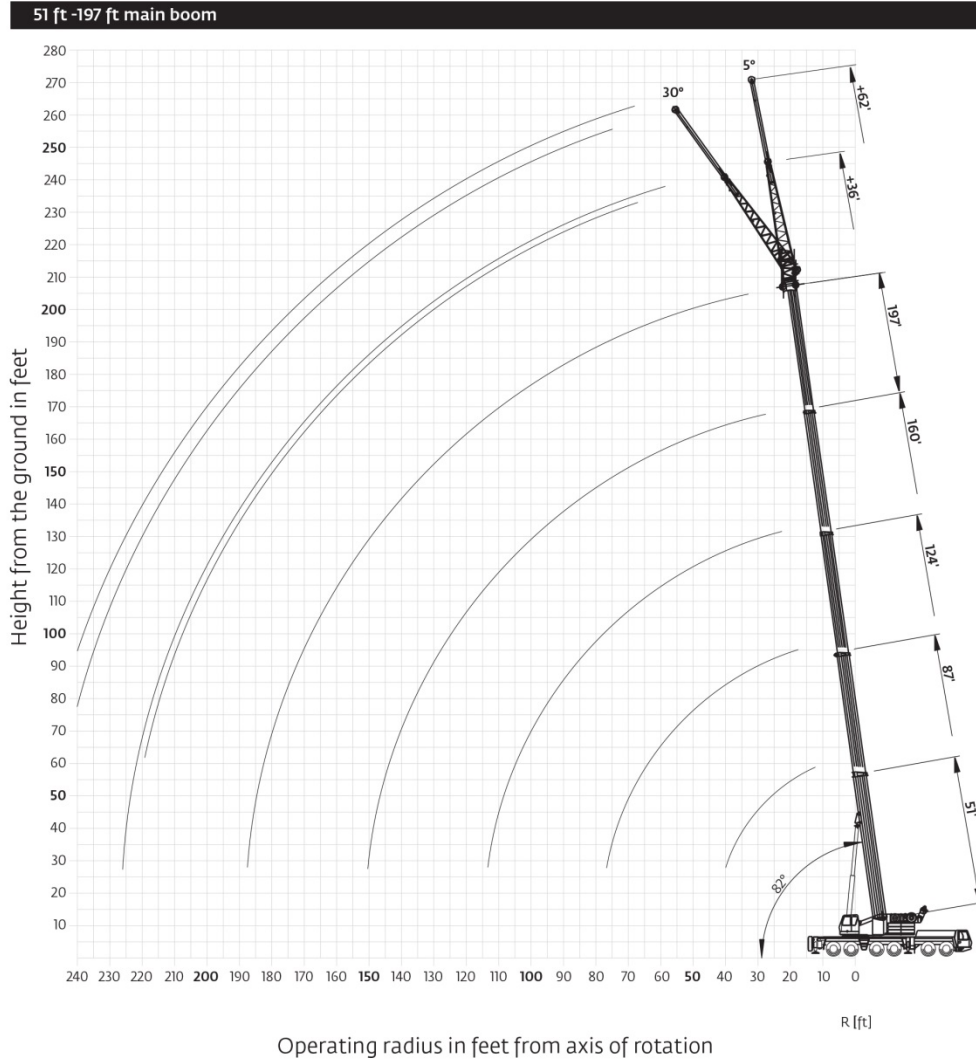



Grove GMK6350

*THIS CHART IS ONLY A GUIDE AND SHOULD NOT BE USED TO OPERATE THE CRANE.  
The individual crane's load chart, operating instructions and other instructional plates must be read and understood prior to operating the crane*

11

## Load charts Main boom

  
 15,5 m - 60,0 m  
(51 ft - 197 ft)

  
 100 t  
(220,400 lb)

  
 8,7 m x 8,5 m  
(28.5 ft x 27.9 ft)  
100%

  
 360°





Pounds x 1000





Feet	51'	51	69	87	106	124	142	160	178	197
8	700.0†									
10	542.0	466.0	422.0	342.0						
15	412.0	370.0	365.0	342.0	242.0					
20	332.0	302.0	302.0	300.0	242.0					
25	266.0	254.0	258.0	254.0	242.0	185.0	139.0			
30	219.0	218.0	222.0	222.0	220.0	185.0	139.0	106.0		66.0
35	185.0	185.0	188.0	188.0	187.0	174.0	137.0	106.0	78.0	66.0
40			162.0	163.0	161.0	161.0	126.0	106.0	78.0	66.0
45			142.0	143.0	141.0	144.0	116.0	102.0	78.0	66.0
50			126.0	126.0	128.0	128.0	106.0	95.0	78.0	66.0
55			113.0	113.0	116.0	114.0	98.0	88.0	78.0	66.0
60			102.0	102.0	105.0	103.0	91.0	82.0	75.0	66.0
65				92.0	95.0	93.0	84.0	76.0	70.0	65.0
70					86.0	85.0	78.0	71.0	66.0	62.0
75					79.0	77.0	73.0	66.0	62.0	59.0
80					72.0	70.0	67.0	62.0	58.0	56.0
85					67.0	65.0	64.0	58.0	54.0	52.0
90					62.0	60.0	61.0	54.0	50.0	49.0
95						55.0	57.0	50.0	47.0	46.0
100						51.0	53.0	48.0	45.0	43.0
105						47.0	50.0	45.0	42.4	41.0
110						45.0	46.0	42.4	40.2	39.0
115							43.2	40.4	38.2	37.0
120								38.6	36.2	35.2
125								37.0	34.4	33.6
130								34.6	32.6	32.0
135								33.4	31.2	30.0
140								32.4	30.0	27.8
145									28.8	26.0
150									27.2	24.8
155									25.6	23.8
160									24.4	22.6
165										21.8
170										20.6
175										19.2
180										17.2

\*Over rear, 28 ft 6 in x 19 ft 8 in outrigger base      †700,000 lb is a comparative rating

  
 15,5 m - 60,0 m  
(51 ft - 197 ft)

  
 50 t  
(110,200 lb)

  
 8,7 m x 8,5 m  
(28.5 ft x 27.9 ft)  
100%

  
 360°



Pounds x 1000



Feet	51	69	87	106	124	142	160	178	197
10	446.0	422.0	342.0						
15	352.0	352.0	342.0	242.0					
20	278.0	282.0	282.0	242.0	185.0	139.0			
25	222.0	224.0	224.0	224.0	185.0	139.0	106.0		
30	180.0	183.0	183.0	182.0	182.0	139.0	106.0	78.0	66.0
35	147.0	150.0	151.0	155.0	150.0	137.0	106.0	78.0	66.0
40		129.0	131.0	130.0	126.0	118.0	106.0	78.0	66.0
45		111.0	113.0	112.0	108.0	102.0	97.0	78.0	66.0
50		95.0	97.0	97.0	94.0	94.0	87.0	78.0	66.0
55		81.0	83.0	83.0	82.0	83.0	79.0	73.0	66.0
60			73.0	72.0	75.0	73.0	70.0	68.0	66.0
65			64.0	63.0	66.0	64.0	64.0	63.0	59.0
70			57.0	59.0	59.0	57.0	58.0	56.0	53.0
75				54.0	53.0	52.0	52.0	51.0	48.0
80				48.0	48.0	48.0	47.0	46.0	43.0
85				43.8	42.8	43.6	42.6	41.2	39.0
90				39.6	38.8	39.6	38.4	37.0	35.4
95					36.2	36.0	34.8	33.4	31.8
100					33.0	32.8	31.6	30.2	28.6
105					30.0	29.8	28.8	27.4	25.6
110					27.6	27.4	26.2	24.8	23.2
115						25.0	23.8	22.6	20.8
120						23.0	21.8	20.4	18.8
125							19.8	18.6	16.8
130							18.2	16.8	15.0
135							16.6	15.2	13.4
140							15.0	13.8	12.0
145								12.4	10.6
150								11.2	9.4
155								10.0	8.2
160								9.0	7.0
165									6.0
170									5.0
175									4.2

THIS CHART IS ONLY A GUIDE AND SHOULD NOT BE USED TO OPERATE THE CRANE.  
The individual crane's load chart, operating instructions and other instructional plates must be read and understood prior to operating the crane

## Load charts Hydraulic offsettable swingaway

54.4 m - 60.0 m (179 ft - 197 ft)    11 m - 19 m (36 ft - 62 ft)    100 t (220,400 lb)    8,7 m x 8,5 m (28.5 ft x 27.9 ft) 100%    360°

**179 ft MAIN BOOM**    **197 ft MAIN BOOM**

Feet	179 ft MAIN BOOM				197 ft MAIN BOOM						
	36 ft	30°	5°	62 ft	30°	5°	36 ft	30°	5°	62 ft	30°
40	45.0			19.0			38.8			18.4	
45	43.6			18.4			38.8			18.2	
50	42.8	32.6		17.6			38.8	30.8		17.6	
55	42.0	31.8		17.0			38.4	30.4		17.0	
60	41.2	31.0		16.2			37.8	30.2		16.2	
65	40.4	30.4		15.6			37.4	29.8		15.8	
70	39.6	29.8		15.0	10.0		36.8	29.6		15.2	
75	39.0	29.2		14.4	9.8		36.4	29.2		14.6	9.8
80	38.2	28.6		14.0	9.6		35.8	28.6		14.2	9.6
85	37.6	28.0		13.6	9.4		35.4	28.2		13.8	9.4
90	36.8	27.6		13.0	9.2		34.4	27.6		13.2	9.4
95	36.0	26.8		12.6	9.2		34.0	27.0		13.0	9.2
100	35.2	25.8		12.2	9.0		34.0	26.0		12.6	9.0
105	34.4	24.8		11.8	8.8		33.6	25.0		12.2	8.8
110	33.4	24.6		11.6	8.6		33.0	24.6		11.8	8.8
115	32.6	24.2		11.2	8.6		32.6	24.4		11.6	8.6
120	31.6	23.8		11.0	8.4		32.0	24.0		11.2	8.6
125	30.8	23.6		10.6	8.4		31.0	23.8		11.0	8.4
130	30.0	23.4		10.4	8.2		30.2	23.6		10.6	8.4
135	28.6	23.2		10.2	8.2		28.6	23.4		10.4	8.2
140	27.2	23.0		10.0	8.0		26.8	23.0		10.2	8.2
145	25.8	22.8		9.6	8.0	25.2	22.8	10.0		8.0	
150	24.6	22.6		9.4	7.8	24.2	22.8	9.8		8.0	
155	23.6	22.4		9.2	7.8	23.0	22.6	9.6		7.8	
160	22.4	22.2		9.0	7.8	22.2	22.2	9.4		7.8	
165	21.0	21.6		8.8	7.6	21.2	21.6	9.2		7.8	
170	20.2	20.4		8.8	7.6	20.2	20.8	9.0		7.6	
175	19.4	19.8		8.6	7.6	19.0	20.0	8.8		7.6	
180	18.8			8.4	7.6	17.8	18.6	8.6		7.6	
185	18.2			8.2	7.4	16.6	17.2	8.6		7.6	
190	17.4			8.2	7.4	15.4	16.0	8.4		7.6	
195				8.0	7.4	14.2		8.2		7.4	
200				7.8	7.4	13.2		8.2		7.4	
205				7.8		12.4		8.0		7.4	
210				7.6				8.0		7.4	
215				7.6				7.8		7.4	
220				7.6				7.8		7.4	
225				7.4				7.6		7.4	
230								7.6		7.4	
235								7.4		7.4	
240								7.4		7.4	

54.4 m - 60.0 m (179 ft - 197 ft)    11 m - 19 m (36 ft - 62 ft)    50 t (110,200 lb)    8,7 m x 8,5 m (28.5 ft x 27.9 ft) 100%    360°

**179 ft MAIN BOOM**    **197 ft MAIN BOOM**

Feet	179 ft MAIN BOOM				197 ft MAIN BOOM						
	36 ft	30°	5°	62 ft	30°	5°	36 ft	30°	5°	62 ft	30°
40	45.0			19.0			38.8			18.4	
45	43.6			18.4			38.8			18.2	
50	42.8	32.6		17.6			38.8	30.8		17.6	
55	42.0	31.8		17.0			38.4	30.4		17.0	
60	41.2	31.0		16.2			37.8	30.2		16.2	
65	40.4	30.4		15.6			37.4	29.8		15.8	
70	39.6	29.8		15.0	10.0		36.8	29.6		15.2	
75	39.0	29.2		14.4	9.8		36.4	29.2		14.6	9.8
80	38.2	28.6		14.0	9.6		35.8	28.6		14.2	9.6
85	36.8	28.0		13.6	9.4		35.4	28.2		13.8	9.4
90	36.0	27.6		13.0	9.2		33.6	27.6		13.2	9.4
95	33.8	26.8		12.6	9.2		30.6	27.0		13.0	9.2
100	30.8	25.8		12.2	9.0		27.8	26.0		12.6	9.0
105	27.8	24.8		11.8	8.8		25.2	25.0		12.2	8.8
110	25.2	24.6		11.6	8.6		23.0	24.6		11.8	8.8
115	23.0	24.0		11.2	8.6		20.8	23.2		11.6	8.6
120	20.8	22.6		11.0	8.4		18.8	21.0		11.2	8.6
125	18.8	20.6		10.6	8.4		16.8	18.8		11.0	8.4
130	17.0	18.6		10.4	8.2		15.0	17.0		10.6	8.4
135	15.4	17.0		10.2	8.2		13.4	15.2		10.4	8.2
140	14.0	15.4		10.0	8.0		12.0	13.6		10.2	8.2
145	12.6	13.8		9.6	8.0		10.6	12.2		10.0	8.0
150	11.2	12.4		9.4	7.8		9.2	10.8		9.8	8.0
155	10.0	11.2		9.2	7.8		8.0	9.4		9.6	7.8
160	9.0	10.0		9.0	7.8		7.0	8.2		9.4	7.8
165	8.0	8.8		8.8	7.6		6.0	7.0		9.2	7.8
170	7.0	7.8		8.6	7.6		5.0	6.0		8.2	7.6
175	6.0	6.8		8.6	7.6		4.0	5.0		7.2	7.6
180	5.2			8.2	7.6		3.2	4.0		6.4	7.6
185	4.4			7.4	7.4			3.2		5.6	7.2
190	3.6			6.6	7.4					4.8	6.4
195				5.8	7.0					4.0	5.6
200				5.2	6.2					3.4	4.6
205				4.4						2.6	3.8
210				3.8							3.2
215				3.2							
220				2.6							

Grove GMK6350

THIS CHART IS ONLY A GUIDE AND SHOULD NOT BE USED TO OPERATE THE CRANE.  
The individual crane's load chart, operating instructions and other instructional plates must be read and understood prior to operating the crane

## Working range with MEGALIFT™



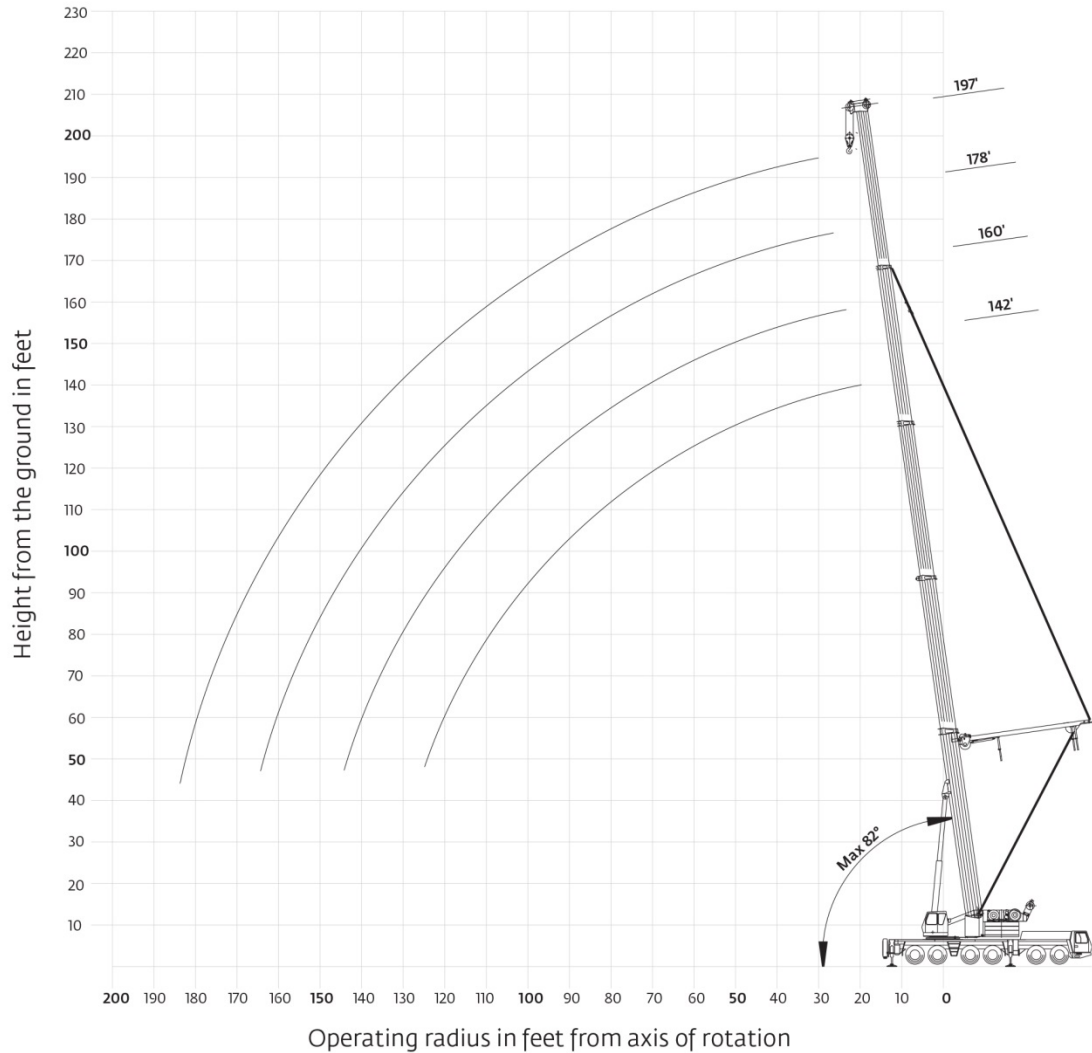

142 ft - 197 ft main boom





*Hook heights shown in the working range diagram do not consider loaded boom deflection.*





*THIS CHART IS ONLY A GUIDE AND SHOULD NOT BE USED TO OPERATE THE CRANE.  
The individual crane's load chart, operating instructions and other instructional plates must be read and understood prior to operating the crane*



## Load charts with MEGALIFT™

 15,5 m - 60,0 m (51 ft - 197 ft)
  100 t (220,400 lb)
  8,7 m x 8,5 m (28.5 ft x 27.9 ft) 100%
  360°

  Pounds x 1000

Feet	142	160	178	197
20	139.0			
25	139.0	106.0		
30	139.0	106.0	78.0	66.0
35	139.0	106.0	78.0	66.0
40	139.0	106.0	78.0	66.0
45	139.0	106.0	78.0	66.0
50	125.0	106.0	78.0	66.0
55	112.0	106.0	78.0	66.0
60	100.0	101.0	78.0	66.0
65	91.0	91.0	78.0	66.0
70	82.0	83.0	78.0	66.0
75	75.0	77.0	76.0	66.0
80	71.0	71.0	70.0	66.0
85	66.0	66.0	64.0	65.0
90	63.0	62.0	59.0	60.0
95	59.0	58.0	56.0	56.0
100	55.0	54.0	53.0	52.0
105	51.0	50.0	49.0	48.0
110	47.0	47.0	46.0	44.0
115	44.0	43.4	42.6	41.2
120	41.4	40.6	39.8	38.4
125		38.0	37.0	35.8
130		35.6	34.6	33.4
135		33.4	32.4	31.0
140		31.2	30.4	29.0
145			28.4	27.0
150			26.6	25.2
155			25.0	23.6
160			23.4	22.0
165				20.6
170				19.2
175				17.8
180				14.4

 15,5 m - 60,0 m (51 ft - 197 ft)
  50 t (110,200 lb)
  8,7 m x 8,5 m (28.5 ft x 27.9 ft) 100%
  360°

  Pounds x 1000

Feet	142	160	178	197
20	139.0			
25	139.0	106.0		
30	139.0	106.0	78.0	66.0
35	139.0	106.0	78.0	66.0
40	122.0	106.0	78.0	66.0
45	105.0	101.0	78.0	66.0
50	96.0	95.0	78.0	66.0
55	89.0	85.0	76.0	66.0
60	78.0	75.0	72.0	66.0
65	69.0	67.0	64.0	60.0
70	61.0	60.0	57.0	54.0
75	54.0	54.0	52.0	48.0
80	49.0	48.0	47.0	43.6
85	43.6	42.8	41.8	39.4
90	39.4	38.6	37.4	35.6
95	35.4	34.6	33.6	32.0
100	32.0	31.2	30.2	28.6
105	29.0	28.2	27.2	25.6
110	26.2	25.4	24.4	23.0
115	23.8	23.0	22.0	20.4
120	21.6	20.8	19.8	18.2
125		18.8	17.8	16.2
130		16.8	15.8	14.4
135		15.2	14.2	12.6
140		13.6	12.6	11.0
145			11.2	9.6
150			9.8	8.2
155			8.6	7.0
160			7.4	5.8
165				4.8
170				3.8

Grove GMK6350 *THIS CHART IS ONLY A GUIDE AND SHOULD NOT BE USED TO OPERATE THE CRANE. The individual crane's load chart, operating instructions and other instructional plates must be read and understood prior to operating the crane*

## Working range Lattice extension

51 ft - 197 ft main boom and lattice extension

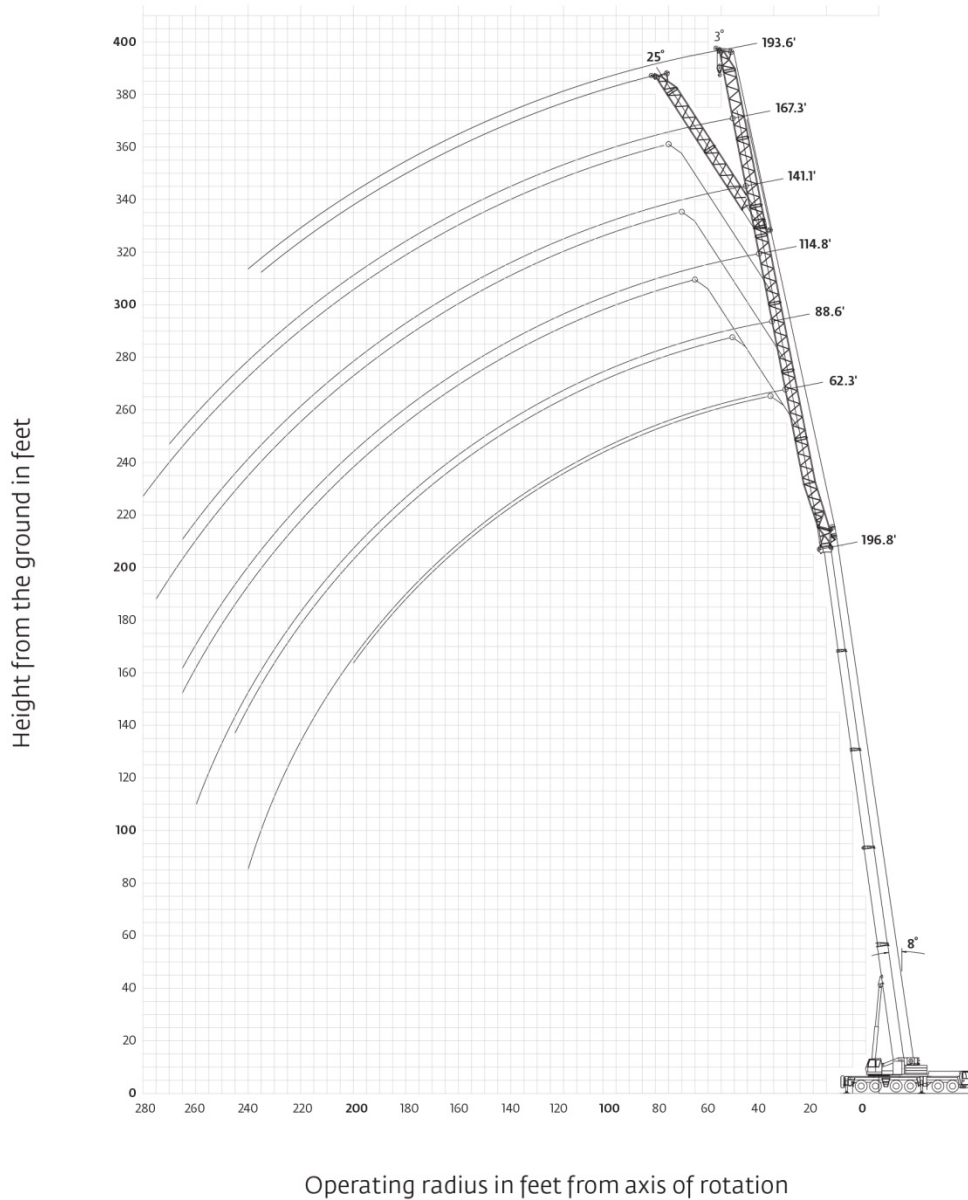

*Hook heights shown in the working range diagram do not consider loaded boom deflection.*

## Load charts Lattice extension

		60,0 m (197 ft)		19,0 m - 60,0 m (62 ft - 194 ft)		100 t (220,400 lb)		8,7 m x 8,5 m (28.5 ft x 27.9 ft) 100%		360°			
		Pounds x 1000											
		62 ft		89 ft		115 ft		141 ft		167 ft		194 ft	
		3°	25°	3°	25°	3°	25°	3°	25°	3°	25°	3°	25°
50	29.2												
55	29.2												
60	29.2	28.6	21.2			16.4							
65	29.2	28.6	21.2			16.4							
70	29.2	28.6	21.2			16.4							
75	29.2	28.6	21.2		20.6	16.4							
80	29.2	28.6	21.2		20.6	16.4							4.8
85	29.2	28.6	21.2		20.6	16.4							4.8
90	29.2	28.6	21.2		20.6	16.4							4.8
95	28.6	27.8	21.2		20.6	16.4		16.2	11.6			9.2	4.8
100	27.6	26.8	21.2		20.2	16.4		16.2	11.6			9.2	4.8
105	26.4	25.4	20.8		19.6	16.4		16.2	11.6		12.2	9.2	4.8
110	25.4	23.8	20.2		19.0	16.4		15.6	11.6		12.2	9.2	4.8
115	24.2	22.8	19.6		18.4	16.2		15.2	11.6		12.2	9.2	4.8
120	23.0	22.0	19.0		17.8	15.6		14.6	11.6		12.2	9.2	4.8
125	21.8	21.2	18.2		17.4	15.2		14.2	11.6		12.0	9.2	4.8
130	20.6	20.4	17.6		16.8	14.6		13.8	11.6		11.6	9.2	4.8
135	19.8	19.8	17.0		16.4	14.2		13.2	11.6		11.2	9.0	4.8
140	19.2	19.2	16.4		15.8	13.8		12.8	11.2		10.8	8.8	4.8
145	18.6	18.6	16.0		15.4	13.2		12.6	11.0		10.6	8.6	4.8
150	18.0	17.8	15.4		15.0	12.8		12.2	10.6		10.2	8.4	4.8
155	17.2	17.2	14.8		14.6	12.4		11.8	10.2		9.8	8.0	4.8
160	16.6	16.6	14.2		14.2	12.0		11.4	9.8		9.6	7.8	4.8
165	16.0	16.0	13.8		13.6	11.6		11.0	9.4		9.2	7.6	4.8
170	15.2	15.2	13.4		13.2	11.2		10.8	9.0		8.8	7.2	4.8
175	14.6	14.6	12.8		12.8	10.8		10.4	8.8		8.6	7.0	4.6
180	13.8	14.0	12.4		12.4	10.4		10.2	8.4		8.4	6.8	4.4
185	13.2	13.4	12.0		12.0	10.2		9.8	8.2		8.0	6.4	4.2
190	12.6	12.6	11.6		11.6	9.8		9.6	7.8		7.8	6.2	4.2
195	11.8	12.0	11.0		11.2	9.4		9.2	7.6		7.4	5.8	4.0
200	10.8	11.2	10.6		10.8	9.2		9.0	7.2		7.2	5.6	3.8
205	9.8	10.2	10.2		10.4	8.8		8.8	7.0		7.0	5.4	3.6
210	9.0	9.2	10.0		10.0	8.4		8.4	6.8		6.8	5.2	3.4
215	8.0	8.2	9.2		9.4	8.2		8.2	6.6		6.6	5.0	3.2
220	7.2	7.4	8.4		9.0	7.8		8.0	6.4		6.4	4.8	3.0
225	6.4		7.6		8.4	7.6		7.6	6.0		6.2	4.6	2.8
230	5.6		6.8		7.4	7.2		7.4	5.8		5.8	4.4	2.6
235	4.8		6.0		6.6	6.6		7.0	5.6		5.6	4.2	2.4
240		3.8	5.2		5.8	6.0		6.8	5.4		5.4	4.0	2.2
245			4.6		5.0	5.2		6.4	5.2		5.2	3.8	2.0
250			4.0		4.6	4.6		5.6	4.8		5.0	3.6	1.8
255			3.2		4.0	4.0		5.0	4.2		4.8	3.4	1.6
260			2.6		3.4	3.4		4.2	3.6		4.6	3.2	1.4
265					2.8	2.8		3.6	3.0		4.2	3.0	1.2
270								3.6	2.6		3.6	2.6	1.0
275									2.8			2.8	0.8
280													0.6

		60,0 m (197 ft)		19,0 m - 60,0 m (62 ft - 194 ft)		50 t (110,200 lb)		8,7 m x 8,5 m (28.5 ft x 27.9 ft) 100%		360°			
		Pounds x 1000											
		62 ft		89 ft		115 ft		141 ft		167 ft		194 ft	
		3°	25°	3°	25°	3°	25°	3°	25°	3°	25°	3°	25°
50	29.2												
55	29.2	28.6	21.2			16.4							
60	29.2	28.6	21.2			16.4							
65	29.2	28.6	21.2			16.4							
70	29.2	28.6	21.2			16.4							
75	29.2	28.6	21.2		20.6	16.4							
80	29.2	28.6	21.2		20.6	16.4							4.8
85	29.2	28.6	21.2		20.6	16.4							4.8
90	29.2	28.6	21.2		20.6	16.4							4.8
95	27.8	27.8	21.2		20.6	16.4							4.8
100	25.0	26.4	21.2		20.2	16.4		16.2	11.6			9.2	4.8
105	22.6	23.8	20.8		19.6	16.4		16.2	11.6		12.2	9.2	4.8
110	20.2	21.4	20.2		19.0	16.4		15.6	11.6		12.2	9.2	4.8
115	18.0	19.2	19.0		18.4	16.2		15.2	11.6		12.2	9.2	4.8
120	16.0	17.2	17.2		17.8	15.6		14.6	11.6		12.2	9.2	4.8
125	14.2	15.4	15.4		17.4	15.2		14.2	11.6		12.0	9.2	4.8
130	12.6	13.6	13.8		16.4	14.0		13.8	11.6		11.6	9.2	4.8
135	11.0	12.0	12.2		14.6	12.4		13.2	11.6		11.2	9.0	4.8
140	9.6	10.4	10.8		13.0	11.0		12.8	11.0		10.8	8.8	4.8
145	8.2	9.0	9.4		11.6	9.8		12.6	9.8		10.6	8.6	4.8
150	7.0	7.8	8.2		10.2	8.4		12.0	8.4		10.2	8.4	4.8
155	5.8	6.4	7.0		9.0	7.4		10.6	7.4		9.8	7.2	4.8
160	4.6	5.2	5.8		7.6	6.2		9.4	6.2		9.4	6.0	4.8
165	3.6	4.2	4.8		6.6	5.2		8.2	5.2		8.2	5.0	4.4
170		3.2	3.8		5.4	4.2		7.0	4.2		7.2	4.2	3.6
175			2.8		4.4	3.2		6.0	3.4		6.2	3.2	3.0
180					3.4			5.0			5.2		2.6
185								4.0			4.2		2.2
190								3.0			3.2		1.8

THIS CHART IS ONLY A GUIDE AND SHOULD NOT BE USED TO OPERATE THE CRANE.

Grove GMK6350 The individual crane's load chart, operating instructions and other instructional plates must be read and understood prior to operating the crane



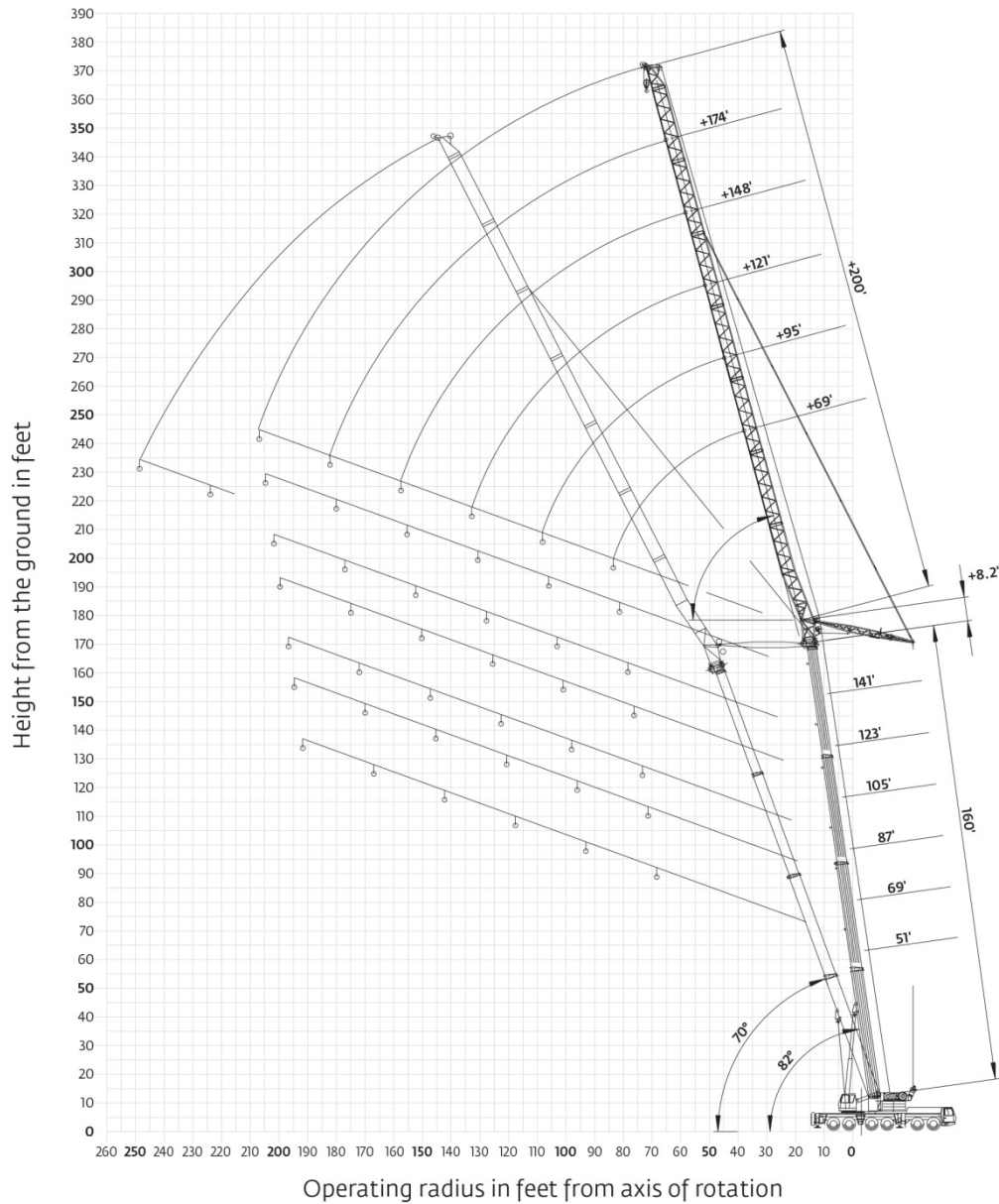

## Working range Luffing jib

51 ft - 160 ft main boom



Hook heights shown in the working range diagram do not consider loaded boom deflection.





## Load charts Luffing jib

15,5 m - 54,3 m (51 ft - 178 ft)    21 m (69 ft)    100 t (220,400 lb)    8,7 m x 8,5 m (28.5 ft x 27.9 ft) 100%    360°

**Pounds x 1000**





Feet	70° Main boom angle							
	51	69	87	105	123	141	160	178
55	115.0							
60	103.0							
65	89.0							
70	76.0	85.0						
75	65.0	79.0	75.0					
80		73.0	70.0					
85		61.0	66.0					
90			62.0	59.0				
95				55.0	51.0			
100					50.0	41.2		
105						41.2	33.0	
110						39.8	33.0	
115							32.4	27.4
120								27.0

15,5 m - 54,3 m (51 ft - 178 ft)    29 m (95 ft)    100 t (220,400 lb)    8,7 m x 8,5 m (28.5 ft x 27.9 ft) 100%    360°

**Pounds x 1000**

Feet	70° Main boom angle							
	51	69	87	105	123	141	160	178
70	84.0							
75	76.0							
80	68.0	73.0						
85	62.0	69.0						
90	55.0	65.0	61.0					
95	49.0	60.0	57.0					
100	43.4	54.0	54.0	51.0				
105		48.0	51.0	48.0	45.0			
110		42.0	48.0	46.0	43.6			
115			46.0	43.6	41.4	35.2		
120				41.4	39.4	34.8	28.0	
125					37.6	33.6	28.0	
130					35.8	32.6	27.0	
135						31.6	26.2	22.0
140							25.6	22.0
145								21.4
150								20.6

15,5 m - 54,3 m (51 ft - 178 ft)    37 m (121 ft)    100 t (220,400 lb)    8,7 m x 8,5 m (28.5 ft x 27.9 ft) 100%    360°

**Pounds x 1000**

Feet	70° Main boom angle							
	51	69	87	105	123	141	160	178
80	61.0							
85	59.0							
90	58.0							
95	54.0	55.0						
100	50.0	54.0	49.0					
105	46.0	53.0	49.0	42.8				
110	42.2	49.0	47.0	42.8				
115	38.2	46.0	45.0	42.8	36.2			
120	34.6	41.6	42.8	40.6	36.2	28.2		
125	31.0	38.0	40.8	38.8	36.2	28.2		
130	27.4	34.2	39.0	37.0	34.8	28.2		
135		30.2	37.2	35.4	33.2	28.2	21.6	
140			33.6	33.8	31.8	28.0	21.6	
145				32.4	30.4	27.4	21.6	16.0
150				31.0	29.2	26.8	21.6	16.0
155					28.0	26.2	21.4	16.0
160						25.2	21.0	16.0
165							20.4	15.8
170							19.8	15.6
175								15.4



Grove GMK6350

THIS CHART IS ONLY A GUIDE AND SHOULD NOT BE USED TO OPERATE THE CRANE.  
The individual crane's load chart, operating instructions and other instructional plates must be read and understood prior to operating the crane.

## Load charts



### Luffing jib

 15,5 m - 54,3 m (51 ft - 178 ft)
  45 m (148 ft)
  100 t (220,400 lb)
  8,7 m x 8,5 m (28.5 ft x 27.9 ft) 100%
  360°

  Pounds x 1000

Feet	70° Main boom angle							
	51	69	87	105	123	141	160	178
95	42.6							
100	42.4							
105	41.8	38.8						
110	41.2	38.6						
115	39.6	38.4	34.8					
120	37.4	38.0	34.8	30.6				
125	35.4	37.6	34.6	30.6	26.4			
130	32.8	36.2	34.4	30.6	26.4			
135	30.4	34.6	34.4	30.4	26.4			
140	27.8	32.6	33.8	30.4	26.4	20.8		
145	25.4	30.4	33.0	30.4	26.4	20.8	15.2	
150	23.2	27.8	32.0	30.2	26.4	20.8	15.2	
155	20.8	25.4	30.0	28.8	26.2	20.6	15.2	
160		23.0	27.4	27.8	25.8	20.6	15.2	10.8
165			25.0	26.6	24.8	20.6	15.2	10.8
170			22.8	25.6	23.8	20.6	15.2	10.8
175				24.6	23.0	20.6	15.2	10.8
180					22.0	20.2	15.2	10.8
185						19.4	15.2	10.8
190							15.2	10.8
195							15.2	10.8
200							15.2	10.8





 15,5 m - 54,3 m (51 ft - 178 ft)
  53 m (174 ft)
  100 t (220,400 lb)
  8,7 m x 8,5 m (28.5 ft x 27.9 ft) 100%
  360°

  Pounds x 1000

Feet	70° Main boom angle							
	51	69	87	105	123	141	160	178
105	29.4							
110	28.6							
115	28.0							
120	27.4	26.6						
125	26.8	25.8	24.6					
130	26.2	24.8	24.2					
135	25.2	24.2	23.6	21.6				
140	24.4	23.8	23.2	21.6	18.8			
145	23.6	23.4	22.8	21.4	18.8			
150	23.0	22.8	22.4	21.2	18.8			
155	22.4	22.4	22.0	20.8	18.6	14.6		
160	21.6	21.8	21.4	20.6	18.6	14.6	10.4	
165	20.0	21.4	21.2	20.2	18.4	14.6	10.4	
170	18.4	21.0	20.8	19.8	18.4	14.6	10.4	
175	17.0	19.8	20.4	19.6	18.2	14.6	10.4	6.6
180	15.6	18.4	19.8	19.2	17.8	14.6	10.4	6.6
185		16.8	18.8	18.8	17.8	14.6	10.4	6.6
190		15.6	17.8	18.6	17.6	14.6	10.4	6.6
195			17.0	18.4	17.4	14.6	10.4	6.6
200				18.0	17.0	14.6	10.4	6.6
205					16.8	14.4	10.4	6.6
210							10.4	6.6
215							10.4	6.6
220							10.4	6.6

## Load charts





### Luffing jib

 15,5 m - 54,3 m (51 ft - 178 ft)
  61 m (200 ft)
  100 t (220,400 lb)
  8,7 m x 8,5 m (28.5 ft x 27.9 ft) 100%
  360°

**Pounds x 1000**

**70° Main boom angle**





Feet	51	69	87	105	123	141	160
120	17.2						
125	16.4						
130	15.8						
135	15.4	16.0					
140	14.8	15.4	15.8				
145	14.4	15.0	15.2	14.8			
150	14.0	14.4	14.8	14.8			
155	13.6	14.0	14.2	14.4	12.6		
160	13.0	13.6	14.0	14.0	12.6		
165	12.6	13.2	13.4	13.6	12.6	9.8	
170	12.2	12.6	13.0	13.2	12.6	9.8	
175	11.8	12.2	12.8	12.8	12.4	9.8	6.0
180	11.6	12.0	12.4	12.4	12.2	9.6	6.0
185	11.4	11.6	12.0	12.0	12.0	9.4	6.0
190	11.0	11.2	11.8	11.8	12.0	9.4	6.0
195	10.8	11.0	11.4	11.4	11.6	9.4	6.0
200	10.6	10.6	11.0	11.0	11.2	9.4	6.0
205	10.2	10.4	11.0	11.0	11.0	9.4	6.0
210		10.2	10.6	10.6	10.8	9.4	6.0
215		10.0	10.4	10.4	10.4	9.4	6.0
220			10.2	10.2	10.2	9.4	6.0
225				10.0	10.0	9.4	6.0
230					9.8	9.2	6.0
235					9.6	9.2	6.0
240						9.0	6.0

 15,5 m - 54,3 m (51 ft - 178 ft)
  21 m (69 ft)
  100 t (220,400 lb)
  8,7 m x 8,5 m (28.5 ft x 27.9 ft) 100%
  360°

**Pounds x 1000**

**82° Main boom angle**

Feet	51	69	87	105	123	141	160	178
30	121.0							
35	121.0							
40	119.0	114.0		84.0				
45	103.0	114.0	99.0	84.0	67.0			
50	88.0	102.0	99.0	84.0	67.0	51.0	37.8	
55	75.0	88.0	96.0	84.0	67.0	51.0	37.8	29.2
60	63.0	74.0	88.0	84.0	67.0	51.0	37.8	29.2
65	52.0	62.0	74.0	84.0	67.0	51.0	37.8	29.2
70		50.0	61.0	74.0	67.0	51.0	37.8	29.2
75					67.0	51.0	37.8	29.2
80						51.0	37.8	29.2
85							37.8	29.2

 15,5 m - 54,3 m (51 ft - 178 ft)
  29 m (95 ft)
  100 t (220,400 lb)
  8,7 m x 8,5 m (28.5 ft x 27.9 ft) 100%
  360°

**Pounds x 1000**

**82° Main boom angle**

Feet	51	69	87	105	123	141	160	178
40	88.0	79.0						
45	88.0	79.0						
50	88.0	78.0	69.0	60.0				
55	84.0	78.0	69.0	60.0	49.0	37.8		
60	76.0	78.0	69.0	60.0	49.0	37.8	28.6	21.6
65	67.0	75.0	69.0	60.0	49.0	37.8	28.6	21.6
70	60.0	68.0	69.0	60.0	49.0	37.8	28.6	21.6
75	54.0	60.0	65.0	60.0	49.0	37.8	28.6	21.6
80	47.0	53.0	59.0	59.0	49.0	37.8	28.6	21.6
85	41.4	47.0	53.0	59.0	49.0	37.8	28.6	21.6
90	35.4	40.8	47.0	53.0	48.0	37.8	28.6	21.6
95			40.4	47.0	46.0	37.8	28.6	21.6
100					43.6	37.8	28.6	21.6
105							28.6	21.6
110								21.6

Grove GMK6350 *THIS CHART IS ONLY A GUIDE AND SHOULD NOT BE USED TO OPERATE THE CRANE. The individual crane's load chart, operating instructions and other instructional plates must be read and understood prior to operating the crane*

## Load charts



### Luffing jib







15,5 m - 54,3 m (51 ft - 178 ft)      37 m (121 ft)      100 t (220,400 lb)      8,7 m x 8,5 m (28.5 ft x 27.9 ft) 100%      360°

  Pounds x 1000

82° Main boom angle



Feet	51	69	87	105	123	141	160	178
50	62.0	56.0						
55	62.0	56.0	50.0	43.0				
60	61.0	55.0	50.0	43.0	36.0	28.0		
65	61.0	55.0	49.0	43.0	36.0	28.0		
70	59.0	55.0	49.0	43.0	36.0	28.0	21.4	15.8
75	56.0	55.0	49.0	42.8	36.0	28.0	21.4	15.8
80	53.0	54.0	49.0	42.8	36.0	28.0	21.4	15.8
85	48.0	51.0	49.0	42.8	36.0	28.0	21.4	15.8
90	44.0	48.0	49.0	42.6	36.0	28.0	21.4	15.8
95	40.0	45.0	47.0	42.6	36.0	28.0	21.4	15.8
100	36.2	40.6	43.8	42.4	36.0	28.0	21.4	15.8
105	32.4	36.4	40.6	42.4	36.0	28.0	21.4	15.8
110	29.0	32.6	36.6	39.0	36.0	28.0	21.4	15.8
115	25.6	28.8	32.8	35.6	36.0	28.0	21.4	15.8
120			28.6	32.2	35.4	28.0	21.4	15.8
125					32.0	28.0	21.4	15.8
130					28.6	28.0	21.4	15.8
135							21.4	15.8











15,5 m - 54,3 m (51 ft - 178 ft)      45 m (148 ft)      100 t (220,400 lb)      8,7 m x 8,5 m (28.5 ft x 27.9 ft) 100%      360°

  Pounds x 1000

82° Main boom angle





Feet	51	69	87	105	123	141	160	178
50	43.8							
55	43.8	39.6						
60	43.6	39.6	35.8	31.0				
65	43.4	39.6	35.6	31.0				
70	43.2	39.2	35.6	31.0	26.6			
75	43.0	39.0	35.4	31.0	26.6	21.0	15.8	11.2
80	42.6	39.0	35.2	30.8	26.6	21.0	15.8	11.2
85	42.4	38.8	35.0	30.8	26.6	21.0	15.8	11.2
90	42.0	38.4	35.0	30.6	26.6	21.0	15.8	11.2
95	40.6	38.4	34.8	30.6	26.4	21.0	15.8	11.2
100	38.6	37.8	34.6	30.6	26.4	21.0	15.8	11.2
105	36.4	36.2	34.2	30.4	26.4	21.0	15.8	11.2
110	33.6	34.8	33.6	30.4	26.4	21.0	15.8	11.2
115	31.0	33.2	32.8	30.2	26.4	21.0	15.8	11.2
120	28.4	31.4	32.4	30.0	26.2	21.0	15.8	11.2
125	25.6	29.0	31.6	29.8	26.2	21.0	15.8	11.2
130	23.4	26.2	29.2	28.2	26.0	21.0	15.8	11.2
135	21.2	23.8	26.6	26.6	25.2	21.0	15.8	11.2
140		21.4	24.2	24.8	24.2	21.0	15.8	11.2
145			21.8	23.2	23.2	21.0	15.8	11.2
150			18.8	21.4	22.0	21.0	15.8	11.2
155					21.0	21.0	15.8	11.2
160								11.2

## Load charts Luffing jib

 15,5 m - 54,3 m (51 ft - 178 ft)
  53 m (174 ft)
  100 t (220,400 lb)
  8,7 m x 8,5 m (28.5 ft x 27.9 ft) 100%
  360°

**Pounds x 1000**

Feet	82° Main boom angle							
	51	69	87	105	123	141	160	178
60	31.6							
65	31.4							
70	31.0	28.2	25.8					
75	30.4	28.2	25.6	22.2	19.0			
80	30.2	28.0	25.4	22.0	19.0	14.4	10.6	
85	29.8	27.8	25.4	22.0	19.0	14.4	10.6	
90	29.4	27.4	25.2	21.8	19.0	14.4	10.6	6.8
95	28.8	27.4	25.0	21.8	19.0	14.4	10.6	6.8
100	28.4	27.0	24.6	21.8	19.0	14.4	10.6	6.8
105	27.6	26.6	24.2	21.6	19.0	14.4	10.6	6.8
110	26.8	26.0	24.0	21.4	18.8	14.4	10.6	6.8
115	26.0	25.4	23.6	21.2	18.8	14.4	10.6	6.8
120	25.4	24.4	23.0	21.2	18.8	14.4	10.6	6.8
125	24.6	23.8	22.6	21.0	18.6	14.4	10.6	6.8
130	23.8	23.4	22.4	20.8	18.6	14.4	10.6	6.8
135	22.8	22.8	22.0	20.4	18.4	14.4	10.6	6.8
140	22.0	22.2	21.4	20.2	18.4	14.4	10.6	6.8
145	21.0	21.6	21.2	19.8	18.0	14.4	10.6	6.8
150	19.2	20.4	20.6	19.6	17.8	14.4	10.6	6.8
155	17.4	18.8	20.2	19.4	17.8	14.4	10.6	6.8
160	15.6	17.4	19.2	19.0	17.6	14.4	10.6	6.8
165		16.0	17.8	18.4	17.2	14.4	10.6	6.8
170		14.2	16.0	17.2	16.6	14.4	10.6	6.8
175			13.8	15.8	16.0	14.4	10.6	6.8
180					15.2	14.4	10.6	6.8
185							10.6	6.8
190							10.6	6.8

 15,5 m - 54,3 m (51 ft - 178 ft)
  61 m (200 ft)
  100 t (220,400 lb)
  8,7 m x 8,5 m (28.5 ft x 27.9 ft) 100%
  360°

**Pounds x 1000**

Feet	82° Main boom angle						
	51	69	87	105	123	141	160
70	21.6	19.8					
75	21.2	19.8	17.8				
80	20.8	19.6	17.6	15.2	12.8		
85	20.4	19.4	17.6	15.2	12.8		
90	19.6	19.4	17.4	15.2	12.8	9.2	6.2
95	19.0	18.8	17.4	15.2	12.8	9.2	6.2
100	18.4	18.0	17.4	15.2	12.8	9.2	6.2
105	17.6	17.6	16.8	15.0	12.8	9.2	6.2
110	17.2	17.0	16.4	14.8	12.8	9.2	6.2
115	16.6	16.4	16.0	14.8	12.8	9.2	6.2
120	15.8	15.8	15.6	14.6	12.6	9.2	6.2
125	15.4	15.2	15.2	14.6	12.6	9.2	6.2
130	14.8	14.8	14.6	14.4	12.6	9.2	6.2
135	14.2	14.2	14.2	14.0	12.6	9.2	6.2
140	13.8	13.8	14.0	13.8	12.4	9.2	6.2
145	13.4	13.4	13.6	13.4	12.2	9.2	6.2
150	13.0	13.0	13.0	12.8	12.2	9.2	6.2
155	12.6	12.6	12.8	12.6	12.0	9.2	6.2
160	12.2	12.2	12.4	12.2	11.8	9.2	6.2
165	11.8	11.8	12.0	11.8	11.6	9.2	6.2
170	11.6	11.6	11.8	11.6	11.2	9.2	6.2
175	11.2	11.2	11.4	11.2	11.2	9.2	6.2
180	10.6	10.8	11.0	11.0	10.8	9.2	6.2
185	10.2	10.4	11.0	10.8	10.4	9.2	6.2
190	10.0	10.2	10.6	10.4	10.4	9.2	6.2
195		9.8	10.2	10.2	10.0	9.2	6.2
200				10.0	10.0	9.2	6.2
205						9.2	6.2
210							6.2
215							6.2

Grove GMK6350 *THIS CHART IS ONLY A GUIDE AND SHOULD NOT BE USED TO OPERATE THE CRANE. The individual crane's load chart, operating instructions and other instructional plates must be read and understood prior to operating the crane*

## Symbols glossary



Axles



Counterweight



Grade



Radius



Boom



Drive



Hoist



Rotation



Boom elevation



Electrical system



Hookblock



Speed



Boom extension



Engine



Hydraulic system



Steering



Boom length



Extension



Lights



Suspension



Boom nose



Frame



Oil



Swing



Brakes



Fuel tank capacity



Outrigger controls



Tires



Cab



Gear



Outriggers



Transmission

**Notes**

Notes

Notes

Grove Manitowoc National Crane Potain



## Manitowoc Cranes

### Regional headquarters

#### Americas

Manitowoc, Wisconsin, USA  
Tel: +1 920 684 6621  
Fax: +1 920 683 6277

Shady Grove, Pennsylvania, USA  
Tel: +1 717 597 8121  
Fax: +1 717 597 4062

#### Europe, Middle East, Africa

Ecully, France  
Tel: +33 (0)4 72 18 20 20  
Fax: +33 (0)4 72 18 20 00

#### China

Shanghai, China  
Tel: +86 21 6457 0066  
Fax: +86 21 6457 4955

#### Greater Asia-Pacific

Singapore  
Tel: +65 6264 1188  
Fax: +65 6862 4040

### Regional offices

#### Americas

**Brazil**  
Alphaville  
**Mexico**  
Monterrey  
**Chile**  
Santiago

#### Europe, Middle East, Africa

**Czech Republic**  
Netvorice  
**France**  
Baudemont  
Cergy  
Decines  
**Germany**  
Langenfeld  
**Hungary**  
Budapest  
**Italy**  
Lainate  
**Netherlands**  
Breda  
**Poland**  
Warsaw  
**Portugal**  
Baltar  
**Russia**  
Moscow  
**U.A.E.**  
Dubai  
**U.K.**  
Buckingham

#### China

Beijing  
Chengdu  
Guangzhou  
Xian

#### Greater Asia-Pacific

**Australia**  
Adelaide  
Brisbane  
Melbourne  
Sydney  
**India**  
Calcutta  
Chennai  
Delhi  
Hyderabad  
Pune  
**Korea**  
Seoul  
**Philippines**  
Makati City  
**Singapore**

### Factories

**Brazil**  
Alphaville  
**China**  
TaiAn  
Zhangjiagang  
**France**  
Charlieu  
Moulins  
**Germany**  
Wilhelmshaven  
**India**  
Pune  
**Italy**  
Niella Tanaro  
**Portugal**  
Baltar  
Fânzeres  
**Slovakia**  
Sarís  
**USA**  
Manitowoc  
Port Washington  
Shady Grove

This document is non-contractual. Constant improvement and engineering progress make it necessary that we reserve the right to make specification, equipment, and price changes without notice. Illustrations shown may include optional equipment and accessories and may not include all standard equipment.